



# Elevate Double Hung Insert

## Replacement Parts

Specifications and technical data are subject to change without notice.

Numbers listed in ( ) parentheses are metric equivalents in millimeters rounded to the nearest whole number.

Suggested fasteners are not included and must be ordered separately.

Illustrations are not to scale.

## Contents

Product History.....	2
Part Identification - Operator .....	3
Part Identification - Picture/Transom.....	4
Installation Parts.....	5
Sash Hardware .....	6
Miscellaneous Parts .....	9
Miscellaneous Parts - Discontinued No Availability (NA).....	10
Balance Tube Replacement.....	11
Top Balance Tubes.....	12
Bottom Balance Tubes.....	16
Jamb/Head Jamb Carrier Assemblies - Configured Part in OMS.....	20
WOCD Field Applied and Replacement Kit .....	21
Vinyl Parts.....	22
Wood Parts - Configured Part in OMS .....	24
Wood Parts.....	25
Weather Strip - Configured Part in OMS.....	26
Weather Strip .....	27
Weather Strip - Discontinued No Availability (NA) .....	30
Weather Strip: Blocks/Seals/Plugs .....	32
Weather Strip: Blocks/Seals/Plugs - Limited Availability (LA).....	33
Screen Replacement - Configured Part in OMS.....	35
Screen Parts .....	36
Screen Parts - Discontinued No Availability (NA).....	37
Sash Replacement - Configured Part in OMS .....	38

Produced	Unit Type	Features and Changes
2013	Double Hung Insert	12/16/2013: Introduced the Elevate Double Hung Insert. The Elevate Double Hung Insert is available in special sizes in increments of 1/64"
2015	Double Hung Insert	08/31/2015: Half Screens introduced.
2016	Double Hung Insert	06/27/2016: Replaced bottom rail extension and weather strip.
2017	Double Hung Insert	12/18/2017: Added the availability of customer specified lite cut configurations for SDL with and with out spacer bar and GBG. To include simulated check rail and any color GBG, to the exterior only, on standard and special sizes.
2018	Double Hung Insert	10/29/2018: Introduced Designer Black and Clear interior finishes and Matte Black (MBK) hardware option. All Balance tubes were changed to Mill Finish for Top and Bottom sash. Generation change to Gen 2. Frame changes: New sill liner profile and jamb liner fabrication (operator). New sill gaskets, jamb liner foam blocks and sill liner tape were also added. Sash changes include: New bottom rail extension (V2948), sash width increased by 0.053. The bottom rail profile was replaced with full frame profile. Low E3 ERS glass type was added. 12/17/2018: Introduced textured glass types: Reed, Narrow Reed, Rain, Glue Chip and Frost and also colored glass types: Clear, Bronze, Gray and Green.
2019	Double Hung Insert	12/16/2019: Discontinued the sale of Wood Removable Grilles.
2020	Double Hung Insert	04/27/2020: Added WOCD field applied and replacement kits (see Product Bulletin 758). 11/16/2020: V2510 frame weather strip was replaced with V3179. A header part stop gasket was added along with a check rail dust block to be used in conjunction with the V3179. See Customer Service Bulletin #177 for more information.
2021	Double Hung Insert	05/17/2021: Incorporated new header end plugs and check rail weather strip, V3203 (Discontinued V1372). 10/25/2021: Replaced sash pivot pins and screen retention plunger, see Product Bulletin 799 for more information. Standard screen mesh changed to Marvin Bright View™, see Product Bulletin 793 for more information. Bottom sash weather strip and jamb carrier assemblies became available as Configured Part in OMS, see Product Bulletin 797 for more information.
2022	Double Hung Insert	04/21/2022: Part numbers were removed for Jamb Carriers (V1327/V3179) and (V1327/V1474) and Lower Sash Bottom Rail Extension (v2948). Configured parts are available in OMS. Any Discontinued - Limited Availability (LA) will continue to be available by part number. See Product Bulletin 829 for more information. 10/31/2022: W8936 was added as a Configured Part in OMS. Part numbers for this profile were removed. See Product Bulletin 852 and 791 for more information. Evergreen exterior discontinued. See Product Bulletin 851 for more information.
2023	Double Hung Insert	02/27/2023: Gunmetal introduced. See Product Bulletin 863 for more information 05/01/2023: V03291 weather strip added for field service use only. See Product Bulletin 885 for more information.

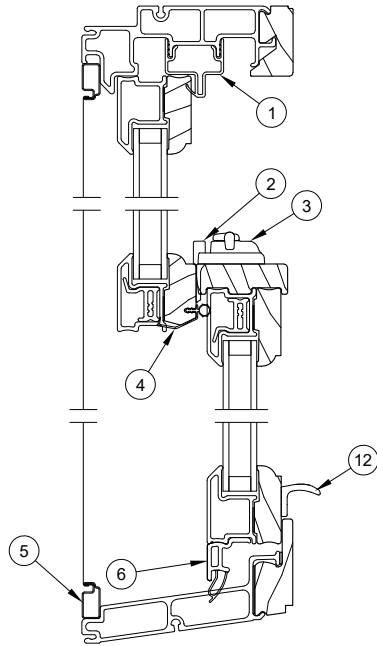

**Head Jamb and Sill**

1. Head Jamb Parting Stop, V1328
2. Sash Keeper
3. Sash Lock
4. Check Rail Weather Strip, V3203
5. Screen Frame
6. Lower Sash Bottom Rail Extension, V2948
7. Sash Pivot Pin
8. Top Sash Balance Tube Assembly
9. Bottom Sash Balance Tube Assembly
10. Jamb Carrier
11. Jamb Weather Strip, V3179
12. Sash Lift

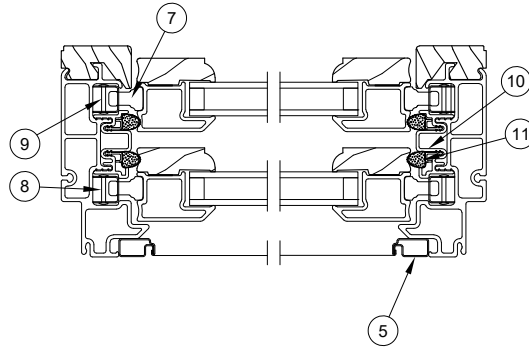

**Jamb**

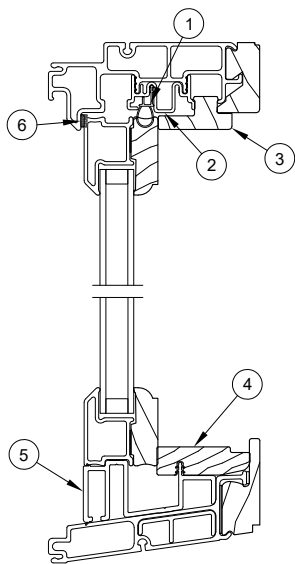

**Head Jamb and Sill**

1. Head Jamb/Jamb Weather Strip, V1474
2. Head Jamb/Jamb Carrier
3. Head Jamb/Jamb Wood Stop, W8936
4. Sill Wood Stop, W11917
5. Sill Filler, V2291
6. Stationary Frame Tape

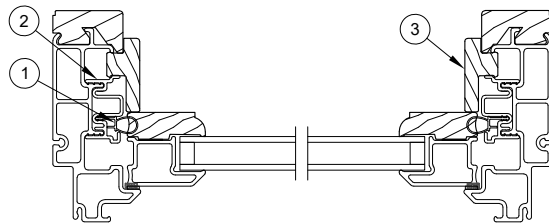

**Jamb**

## Through Jamb Plug

### Usage dates:

12/16/2013 to present

Color	PN
Beige	11882969
Black	11882971
Stone White	11882970

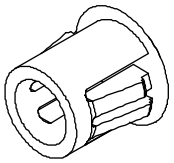

## Cam Lock

### Usage dates:

January 2006 to present

Color	PN
Almond Frost	10150055
White	10150053
Oil Rubbed Bronze	10150095
Satin Nickel	10150093
Brass	10150091
Matte Black	10150097

Suggested Fasteners	
2 - #6x1 1/2" Phillips flat head screws	
Color	PN
Almond Frost	11800341
White	11800340
Oil Rubbed Bronze	11800344
Satin Nickel	11800343
Brass	11800342
Matte Black	11800348

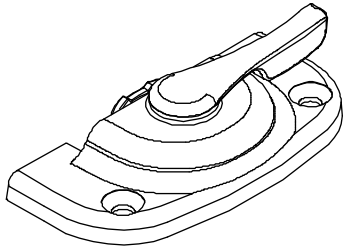

## Lock Spacer

NOTE: FOR FIELD SERVICE ONLY

### Usage dates:

January 2006 to present

Color	PN
White	10506252
Black	10506352

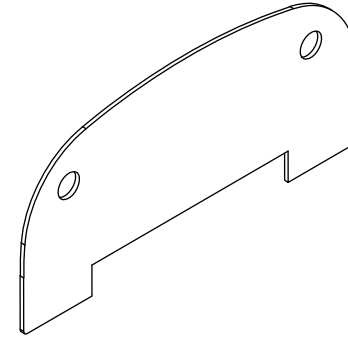

## Pivot Pin, Top Sash

### Usage dates:

10-25-2021 to present

PN	Suggested Fasteners
10815444	1 - #7-16 x 7/8" Phillips flat head screw
PN	
11800798	



## Pivot Pin, Bottom Sash

### Usage dates:

10-25-2021 to present

PN	Suggested Fasteners
10815255	1 - #7-16 x 7/8" Phillips flat head screw
PN	
11800798	



## Keeper

### Usage dates:

January 2006 to present

Color	PN
Almond Frost	10840046
White	10840045
Oil Rubbed Bronze	10840049
Satin Nickel	10840048
Brass	10840047
Matte Black	10840050

Suggested Fasteners	
2 - #6x1 1/2" Phillips flat head screws	
Color	PN
Almond Frost	11800341
White	11800340
Oil Rubbed Bronze	11800344
Satin Nickel	11800343
Brass	11800342
Matte Black	11800348

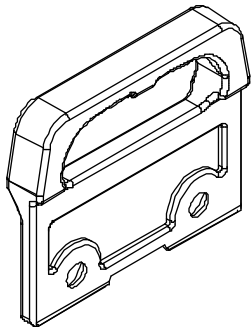

## Sash Lift Kit

### Includes:

- 1 - Sash lift
- 2 - #6 x 1 1/2" Phillips flat head screws and instructions

### Usage dates:

12/16/2013 to present

Color	PN
Almond Frost	11896664
White	11896665
Oil Rubbed Bronze	11896666
Satin Nickel	11896667
Brass	11896668
Matte Black	11896663

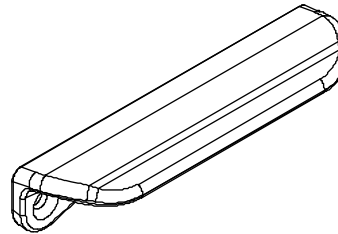

## Top Tilt Latch

### Includes:

1 - #7-19 x 1 1/4" Phillips pan head, full thread screw

### Usage dates:

January 2006 to present

Color	PN
Beige	11869708

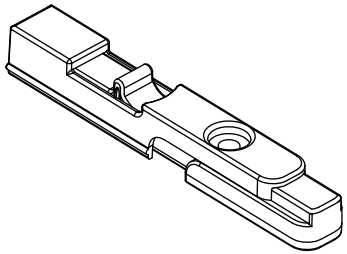

## Bottom Tilt Latch

### Usage dates:

January 2006 to present

Color	PN
Almond Frost	11869707
White	11869705
Oil Rubbed Bronze	11869753
Satin Nickel	11869752
Brass	11869751
Black	11869709

Suggested Fasteners	
2 - #7x1 1/4" Phillips pan head screws	
Color	PN
Almond Frost	11807161
White	11807160
Oil Rubbed Bronze	11807165
Satin Nickel	11807164
Brass	11807163
Black	11807169

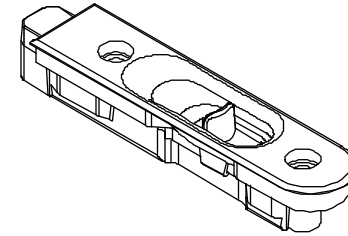



## Balance Tube Plug

### Usage dates:

12/16/2013 to present

PN
10500174

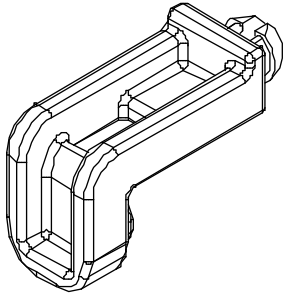

## Rotating Hanger Clip

### Usage dates:

12/16/2013 to present

PN
106610

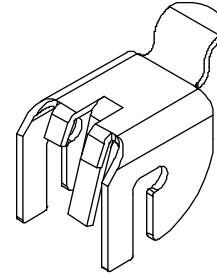

## Balance Tube Clutch

### Usage dates:

12/16/2013 to present

Color	PN
Gray	105530

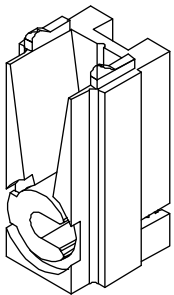

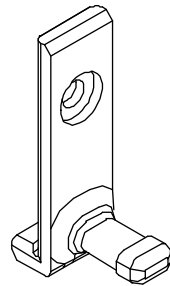

**Pivot Pin, Top Sash**

No Availability, replace with  
current  
Usage dates: January 2006 to  
October 25, 2021

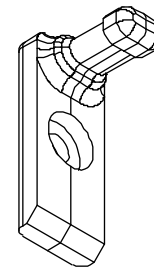

**Pivot Pin, Bottom Sash**

No Availability, replace with  
current  
Usage dates: January 2006 to  
October 25, 2021

## Balance Tube Replacement

### To order, specify:

1. Provide the original order number when possible;
2. Specify top or bottom sash;
3. Balance type and balance ID code (printed on balance tube as shown in illustration below);
4. Weight of sash;
5. Specify quantity. Do NOT specify as pairs or sets. If 1 tube is needed, order 1. If 4 balances are needed, order 4.

NOTE: As of October 29, 2018, all balance tubes will be mill finish. This change may result in mixed tube colors. If desired a second balance tube can be ordered to maintain a consistent appearance.

### Usage dates:

12/16/2013 to present



Top Balance Tubes		
Part Number	Balance ID Code	Length (in)
10665028	226-28	12
10665128	304-28	12
10665228	368-28	12
10665328	42-28	12
10778128	8128	12
10778228	8228	12
10778328	8328	12
10778428	8428	12
10778528	8528	12

Top Balance Tubes		
Part Number	Balance ID Code	Length (in)
10665030	226-30	13
10665130	304-30	13
10665230	368-30	13
10665330	42-30	13
10778130	8130	13
10778230	8230	13
10778330	8330	13
10778430	8430	13
10778530	8530	13

Top Balance Tubes		
Part Number	Balance ID Code	Length (in)
10665032	226-32	14
10665132	304-32	14
10665232	368-32	14
10665332	42-32	14
10778132	8132	14
10778232	8232	14
10778332	8332	14
10778432	8432	14
10778532	8532	14

Top Balance Tubes		
Part Number	Balance ID Code	Length (in)
10665034	226-34	15
10665134	304-34	15
10665234	368-34	15
10665334	42-34	15
10778134	8134	15
10778234	8234	15
10778334	8334	15
10778434	8434	15
10778534	8534	15

Top Balance Tubes		
Part Number	Balance ID Code	Length (in)
10665036	226-36	16
10665136	304-36	16
10665236	368-36	16
10665336	42-36	16
10778136	8136	16
10778236	8236	16
10778436	8436	16
10778536	8536	16

Top Balance Tubes		
Part Number	Balance ID Code	Length (in)
10665038	226-38	17
10665138	304-38	17
10665238	368-38	17
10665338	42-38	17
10778138	8138	17
10778238	8238	17
10778338	8338	17
10778438	8438	17
10778538	8538	17

Top Balance Tubes		
Part Number	Balance ID Code	Length (in)
10665040	226-40	18
10665140	304-40	18
10665240	368-40	18
10665340	42-40	18
10778140	8140	18
10778240	8240	18
10778340	8340	18
10778440	8440	18
10778540	8540	18

Top Balance Tubes		
Part Number	Balance ID Code	Length (in)
10665042	226-42	19
10665142	304-42	19
10665242	368-42	19
10665342	42-42	19
10778142	8142	19
10778242	8242	19
10778342	8342	19
10778442	8442	19
10778542	8542	19

Top Balance Tubes		
Part Number	Balance ID Code	Length (in)
10665044	226-44	20
10665144	304-44	20
10665244	368-44	20
10665344	42-44	20
10778144	8144	20
10778244	8244	20
10778344	8344	20
10778444	8444	20
10778544	8544	20

Top Balance Tubes		
Part Number	Balance ID Code	Length (in)
10665046	226-46	21
10665146	304-46	21
10665246	368-46	21
10665346	42-46	21
10778146	8146	21
10778246	8246	21
10778346	8346	21
10778446	8446	21
10778546	8546	21

Top Balance Tubes		
Part Number	Balance ID Code	Length (in)
10665048	226-48	22
10665148	304-48	22
10665248	368-48	22
10665348	42-48	22
10778148	8148	22
10778248	8248	22
10778348	8348	22
10778448	8448	22
10778548	8548	22

Top Balance Tubes		
Part Number	Balance ID Code	Length (in)
10665050	226-50	23
10665150	304-50	23
10665250	368-50	23
10665350	42-50	23
10778150	8150	23
10778250	8250	23
10778350	8350	23
10778450	8450	23

Top Balance Tubes		
Part Number	Balance ID Code	Length (in)
10665052	226-52	24
10665152	304-52	24
10665252	368-52	24
10665352	42-52	24
10778152	8152	24
10778252	8252	24
10778352	8352	24
10778452	8452	24
10778552	8552	24

Top Balance Tubes		
Part Number	Balance ID Code	Length (in)
10665054	226-54	25
10665154	304-54	25
10665254	368-54	25
10665354	42-54	25
10778154	8154	25
10778254	8254	25
10778354	8354	25
10778454	8454	25
10778554	8554	25

Top Balance Tubes		
Part Number	Balance ID Code	Length (in)
10665056	226-56C68	26
10665156	304-56C68	26
10665256	368-56C68	26
10778156	8156	26
10778256	8256	26
10778356	8356	26
10778456	8456	26
10778556	8556	26

Top Balance Tubes		
Part Number	Balance ID Code	Length (in)
10665058	226-58	27
10665158	304-58	27
10665258	368-58	27
10665358	42-58	27
10778158	8158	27
10778258	8258	27
10778358	8358	27
10778458	8458	27
10778558	8558	27

Top Balance Tubes		
Part Number	Balance ID Code	Length (in)
10665060	226-60	28
10665160	304-60	28
10665260	368-60	28
10665360	42-60	28
10778160	8160	28
10778260	8260	28
10778360	8360	28
10778460	8460	28
10778560	8560	28

Top Balance Tubes		
Part Number	Balance ID Code	Length (in)
10665062	226-62	29
10665162	304-62	29
10665262	368-62	29
10665362	42-62	29
10778162	8162	29
10778262	8262	29
10778362	8362	29
10778562	8562	29

Top Balance Tubes		
Part Number	Balance ID Code	Length (in)
10665064	226-64	30
10665164	304-64	30
10665264	368-64	30
10665364	42-64	30
10778164	8164	30
10778264	8264	30
10778364	8364	30
10778464	8464	30
10778564	8564	30

Top Balance Tubes		
Part Number	Balance ID Code	Length (in)
10665066	226-66	31
10665166	304-66	31
10665266	368-66	31
10665366	42-66	31
10778166	8166	31
10778266	8266	31
10778366	8366	31
10778466	8466	31
10778566	8566	31

Top Balance Tubes		
Part Number	Balance ID Code	Length (in)
10665068	226-68	32
10665168	304-68	32
10665268	368-68	32
10665368	42-68	32
10778169	8169	32
10778269	8269	32
10778369	8369	32
10778469	8469	32
10778569	8569	32

Top Balance Tubes		
Part Number	Balance ID Code	Length (in)
10665070	226-70	33
10665170	304-70	33
10665270	368-70	33
10665370	42-70	33
10778170	8170	33
10778270	8270	33
10778370	8370	33
10778470	8470	33
10778570	8570	33

Top Balance Tubes		
Part Number	Balance ID Code	Length (in)
10665072	226-72	34
10665172	304-72	34
10665272	368-72	34
10665372	42-72	34
10778172	8172	34
10778272	8272	34
10778372	8372	34
10778472	8472	34
10778572	8572	34

Top Balance Tubes		
Part Number	Balance ID Code	Length (in)
10665074	226-74	35
10665174	304-74	35
10665274	368-74	35
10665374	42-74	35
10778174	8174	35
10778274	8274	35
10778374	8374	35
10778474	8474	35
10778574	8574	35

Top Balance Tubes		
Part Number	Balance ID Code	Length (in)
10665076	226-76	36
10665176	304-76	36
10665276	368-76	36
10665376	42-76	36
10778176	8176	36
10778276	8276	36
10778376	8376	36
10778476	8476	36
10778576	8576	36

Top Balance Tubes		
Part Number	Balance ID Code	Length (in)
10665078	226-78	37
10665178	304-78	37
10665278	368-78	37
10665378	42-78	37
10778178	8178	37
10778278	8278	37
10778378	8378	37
10778478	8478	37
10778578	8578	37

Top Balance Tubes		
Part Number	Balance ID Code	Length (in)
10665080	226-80	38
10665180	304-80	38
10665280	368-80	38
10665380	42-80	38
10778180	8180	38
10778280	8280	38
10778380	8380	38
10778480	8480	38

Top Balance Tubes		
Part Number	Balance ID Code	Length (in)
10665082	226-82	39
10665182	304-82	39
10665282	368-82	39
10665382	42-82	39
10778182	8182	39
10778282	8282	39
10778382	8382	39
10778482	8482	39
10778582	8582	39

Top Balance Tubes		
Part Number	Balance ID Code	Length (in)
10665084	226-84	40
10665184	304-84	40
10665284	368-84	40
10665384	42-84	40
10778184	8184	40
10778284	8284	40
10778384	8384	40
10778484	8484	40

Bottom Balance Tubes		
Part Number	Balance ID Code	Length (in)
10777028	226-28	12.875
10777128	304-28	12.875
10777228	368-28	12.875
10779328	9328	12.875
10777328	42-28	12.875
10779128	9128	12.875
10779428	9428	12.875

Bottom Balance Tubes		
Part Number	Balance ID Code	Length (in)
10777030	226-30	13.875
10777130	304-30	13.875
10777230	368-30	13.875
10777330	42-30	13.875
10779130	9130	13.875
10779230	9230	13.875

Bottom Balance Tubes		
Part Number	Balance ID Code	Length (in)
10777032	226-32	14.875
10777132	304-32	14.875
10777232	368-32	14.875
10777332	42-32	14.875

Bottom Balance Tubes		
Part Number	Balance ID Code	Length (in)
10777034	226-34	15.875
10777134	304-34	15.875
10777234	368-34	15.875
10777334	42-34	15.875
10779234	9234	15.875

Bottom Balance Tubes		
Part Number	Balance ID Code	Length (in)
10777036	226-36	16.875
10777136	304-36	16.875
10777236	368-36	16.875
10777336	42-36	16.875
10779236	9236	16.875
10779136	9136	16.875
10779336	9336	16.875
10779436	9436	16.875

Bottom Balance Tubes		
Part Number	Balance ID Code	Length (in)
10777038	226-38	17.875
10777138	304-38	17.875
10777238	368-38	17.875
10777338	42-38	17.875
10779338	9338	17.875
10779238	9238	17.875

Bottom Balance Tubes		
Part Number	Balance ID Code	Length (in)
10777040	226-40	18.875
10777140	304-40	18.875
10777240	368-40	18.875
10777340	42-40	18.875
10779340	9340	18.875
10779440	9440	18.875

Bottom Balance Tubes		
Part Number	Balance ID Code	Length (in)
10777042	226-42	19.875
10777142	304-42	19.875
10777242	368-42	19.875
10777342	42-42	19.875
10779142	9142	19.875
10779442	9442	19.875
10779242	9242	19.875



Bottom Balance Tubes		
Part Number	Balance ID Code	Length (in)
10777044	226-44	20.875
10777144	304-44	20.875
10777244	368-44	20.875
10777344	42-44	20.875
10779144	9144	20.875
10779244	9244	20.875
10779444	9444	20.875
10779344	9344	20.875

Bottom Balance Tubes		
Part Number	Balance ID Code	Length (in)
10777046	226-46	21.875
10777146	304-46	21.875
10777246	368-46	21.875
10779146	9146	21.875
10777346	42-46	21.875
10779346	9346	21.875
10779446	9446	21.875
10779246	9246	21.875

Bottom Balance Tubes		
Part Number	Balance ID Code	Length (in)
10777048	226-48	22.875
10777148	304-48	22.875
10777248	368-48	22.875
10779248	9248	22.875
10779148	9148	22.875
10779348	9348	22.875
10779448	9448	22.875

Bottom Balance Tubes		
Part Number	Balance ID Code	Length (in)
10777050	226-50	23.875
10777150	304-50	23.875
10777250	368-50	23.875
10777350	42-50	23.875
10779350	9350	23.875
10779150	9150	23.875
10779250	9250	23.875

Bottom Balance Tubes		
Part Number	Balance ID Code	Length (in)
10777052	226-52	24.875
10777152	304-52	24.875
10777252	368-52	24.875
10777352	42-52	24.875
10779252	9252	24.875
10779352	9352	24.875

Bottom Balance Tubes		
Part Number	Balance ID Code	Length (in)
10777054	226-54	25.875
10777154	304-54	25.875
10777254	368-54	25.875
10777354	42-54	25.875
10779154	9154	25.875
10779254	9254	25.875

Bottom Balance Tubes		
Part Number	Balance ID Code	Length (in)
10777056	226-56	26.875
10777156	304-56	26.875
10777256	368-56	26.545
10779155	9155	26.545
10777356	42-56	26.545
10779255	9255	26.545
10777255	368-55	26.875
10777355	42-55	26.875
10779256	9256	26.875
10779456	9456	26.875
10779356	9356	26.875
10779556	9556	26.875

Bottom Balance Tubes		
Part Number	Balance ID Code	Length (in)
10777058	226-58	27.875
10777158	304-58	27.875
10777258	368-58	27.875
10777358	42-58	27.875
10779358	9358	27.875
10779158	9158	27.875
10779458	9458	27.875
10779258	9258	27.875
10779558	9558	27.875

Bottom Balance Tubes		
Part Number	Balance ID Code	Length (in)
10777060	226-60	28.875
10777160	304-60	28.875
10777260	368-60	28.875
10777261	368-61	28.545
10777360	42-60	28.875
10777359	42-59	28.545
10779160	9160	28.875
10779159	9159	28.545
10779260	9260	28.875
10779460	9460	28.875

Bottom Balance Tubes		
Part Number	Balance ID Code	Length (in)
10777062	226-62	29.875
10777162	304-62	29.875
10777262	368-62	29.875
10777362	42-62	29.875
10779162	9162	29.875
10779562	9562	29.875
10779262	9262	29.875

Bottom Balance Tubes		
Part Number	Balance ID Code	Length (in)
10777064	226-64	30.875
10777164	304-64	30.875
10777264	368-64	30.875
10777364	42-64	30.875
10779364	9364	30.875

Bottom Balance Tubes		
Part Number	Balance ID Code	Length (in)
10777066	226-66	31.875
10777166	304-66	31.875
10777266	368-66	31.875
10777366	42-66	31.875
10779166	9166	31.875
10779366	9366	31.875
10779266	9266	31.875
10779566	9566	31.875

Bottom Balance Tubes		
Part Number	Balance ID Code	Length (in)
10777068	226-68	32.875
10777168	304-68	32.875
10777268	368-68	32.875
10777368	42-68	32.875
10779269	9269	32.875
10779469	9469	32.875
10779569	9569	32.875

Bottom Balance Tubes		
Part Number	Balance ID Code	Length (in)
10777070	226-70	33.875
10777170	304-70	33.875
10777270	368-70	33.875
10777370	42-70	33.875
10779170	9170	33.875
10779370	9370	33.875
10779270	9270	33.875
10779470	9470	33.875

Bottom Balance Tubes		
Part Number	Balance ID Code	Length (in)
10777072	226-72	34.875
10777172	304-72	34.875
10777272	368-72	34.875
10777372	42-72	34.875
10779372	9372	34.875
10779472	9472	34.875

Bottom Balance Tubes		
Part Number	Balance ID Code	Length (in)
10777074	226-74	35.875
10777174	304-74	35.875
10777274	368-74	35.875
10777374	42-74	35.875
10779174	9174	35.875
10779374	9374	35.875
10779474	9474	35.875
10779274	9274	35.875

Bottom Balance Tubes		
Part Number	Balance ID Code	Length (in)
10777076	226-76C68	36.875
10777176	304-76C68	36.875
10777276	368-76C68	36.875
10777376	42-76C68	36.875
10779276	9276	36.875
10779376	9376	36.875
10779476	9476	36.875

Bottom Balance Tubes		
Part Number	Balance ID Code	Length (in)
10777078	226-78	37.875
10777178	304-78	37.875
10777278	368-78	37.875
10777378	42-78	37.875
10779178	9178	37.875
10779278	9278	37.875
10779378	9378	37.875
10779478	9478	37.875

Bottom Balance Tubes		
Part Number	Balance ID Code	Length (in)
10777080	226-80	38.875
10777180	304-80	38.875
10777280	368-80	38.875
10777380	42-80	38.875
10779180	9180	38.875
10779280	9280	38.875
10779480	9480	38.875

Bottom Balance Tubes		
Part Number	Balance ID Code	Length (in)
10777082	226-82	39.875
10777182	304-82	39.875
10777282	368-82	39.875
10777382	42-82	39.875
10779182	9182	39.875
10779282	9282	39.875
10779482	9482	39.875

Bottom Balance Tubes		
Part Number	Balance ID Code	Length (in)
10777084	226-84	40.875
10777184	304-84	40.875
10777284	368-84	40.875
10777384	42-84	40.875
10779184	9184	40.875
10779284	9284	40.875
10779384	9384	40.875

## Ordering Specifications for Configured Part in OMS:

1. Interior and exterior color;
2. Unit size (inside opening or frame size);
3. Sash division: Standard, Cottage, or Reverse Cottage
4. Weather strip color;
5. Location of Jamb Carrier (from exterior view);
  - a. Left jamb,
  - b. Right jamb.
6. Prep for through jamb;
7. Sill angle.

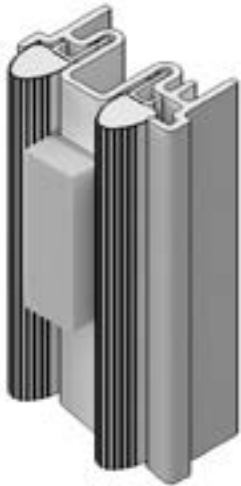

### Jamb Carrier Assembly, Operator

V1327 Vinyl Jamb Carrier and V3179 Frame Weather Strip

NOTE: Full assembly shown for illustrative purposes only.



### Jamb/Head Jamb Carrier Assembly, Picture or Transom

V1327 Vinyl Jamb Carrier and V1474 Frame Weather Strip

NOTE: Full assembly shown for illustrative purposes only.

# WOCD Field Applied and Replacement Kit

## Includes:

- 1 - Field installation instruction
- 1 - Hang tag
- 2 - Safety and operating instructions
- 1 - WOCD sticker
- 2 - Mini AVL WOCD
- 2 - WOCD faceplate
- 4 - WOCD faceplate screws, #6-12 x 1 1/2"
- 2 - Check rail landing pad (Clear 10501055, White 10501056, Black 10501057)

Color	PN
Beige	11903905
Black	11903906
Stone White	11903904

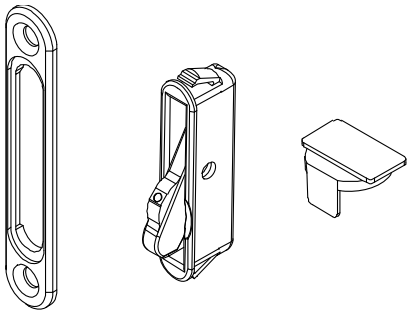

NOTE: For windows without factory-applied WOCD, refer to Product Bulletin 758 for more information.

## Head Jamb Parting Stop

V1328

### Usage dates:

12/16/2013 to present

CN	Length	Beige PN	Black PN	White PN
22	19 3/32" (485)	17003322	17005522	17005622
26	23 3/32" (587)	17003326	17005526	17005626
30	24 3/32" (688)	17003330	17005530	17005630
32	29 3/32" (739)	17003332	17005531	17005632
34	31 3/32" (790)	17003334	17005534	17005634
36	33 3/32" (841)	17003336	17005536	17005636
38	35 3/32" (891)	17003338	17005538	17005638
42	39 3/32" (993)	17003342	17005542	17005642
48	45 3/32" (1145)	17003348	17005548	17005648
54	51 3/32" (1298)	17003354	17005554	17005654

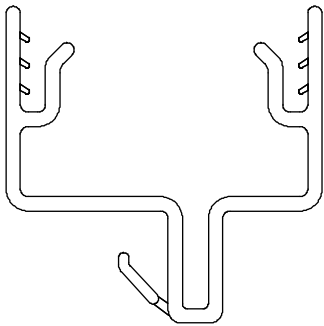

## Sash Stop

V2132

### Usage dates:

12/16/2013 to present

Description	Length	Beige PN	Black PN	White PN
Standard units	2 3/16" (56)	11870224	11880224	11890224
Insert Units	6" (152)	11870806	11880806	11890806
Reverse Cottage	8" (203)	11870808	11880808	11890808
Reverse Cottage	12" (305)	11870812	11880812	11890812
Reverse Cottage	13 1/2" (343)	11870813	11880813	11890813
Reverse Cottage	14 5/8" (371)	11870814	11880814	11890814
Lineal	50" (1270)	11870850	11880850	11890850

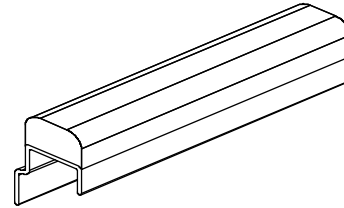

## Sill Filler, Picture/Transom

V2291

### Usage dates:

12/16/2013 to present

CN	Length	Color and Part Number						
		Cashmere	Stone White	Pebble	Bronze	Ebony	Gunmetal	*Evergreen
38	35 1/8" (892)	17001638	17001138	17001238	17001538	17001938	17881138	17001338
50	47 1/8" (1197)	17001650	17001150	17001250	17001530	17001950	17881150	17001350
62	59 1/8" (1502)	17001662	17001162	17001262	17001532	17001962	17881162	17001362

NOTE: \*DISC (LA) used prior to 10/29/2022

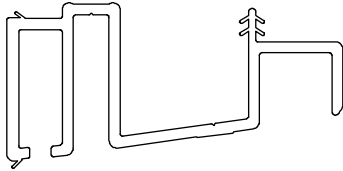

To order, refer to Configured Part in OMS

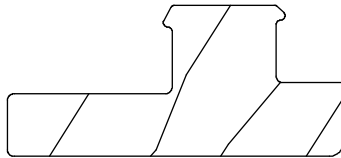

**Interior Stop, Jamb/Head Jamb (Picture/Transom)**

W8936

Used: January 2006 to present



## Sill Stop (Picture/Transom)

W11917

### Usage dates:

12/16/2013 to present

CN	Length	Finish and Part Number			
		Bare Wood	White	Designer Black	Clear
38	35 1/8" (892)	31510838	39210838	39229538	31619038
50	47 1/8" (1197)	31510850	39210850	39229550	31619050
62	59 1/8" (1502)	31510862	39210862	39229562	31619062

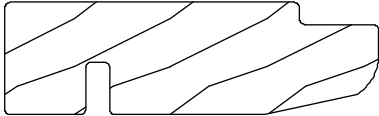

### Ordering specifications for Configured Part in OMS:

- 1. Unit type;
- 2. Unit size (rough opening or frame size);
- 3. Interior and exterior color.

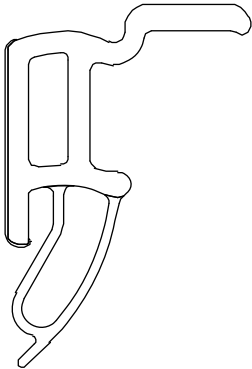

**Lower Sash Bottom Rail Extension**

V2948

Suggested Fasteners
Qty of 12 recommended. PNs will use 6 to 12 depending on size #8-15 x 3/4" Type A/Tek-2, Phillips, pan head, full thread screw.
PN
11806130

## Frame Weather Strip, Operator

V3179

NOTE: Use the PNs shown below to replace any V3179 weather strip size.

### Usage dates:

11/16/2020 to present

CN	Length	Color	PN
Lineal	50" (1270)	Beige	27013800
		Black	28013800
		White	29013800

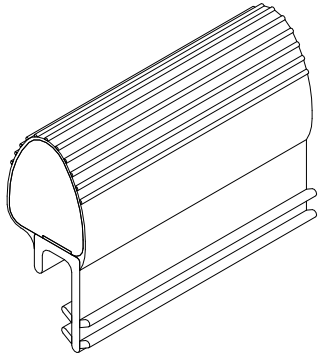

## Frame Weather Strip, Operator

V03291

NOTE: For Field Service Use only to replace V3179. Can be used on product produced 01/2006 to present.

### Usage dates:

5/1/2023 to present

CN	Length	Color	PN
Lineal	100" (2540)	Beige	15353205
		Black	15353215
		White	15353210

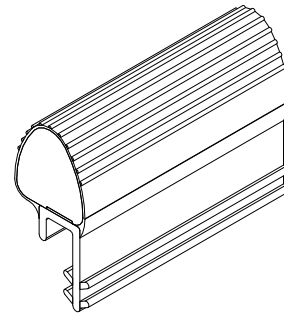

# Frame Weather Strip, Picture and Transom

V1474

## Usage dates:

12/16/2013 to present

Head Jamb		
CN	Length	Beige PN
22	18 7/8" (479)	17030022
26	22 7/8" (581)	17030026
30	26 7/8" (683)	17030030
32	28 7/8" (733)	17030032
34	30 7/8" (784)	17030034
36	32 7/8" (835)	17030036
38	34 7/8" (886)	17030038
42	38 7/8" (987)	17030042
48	44 7/8" (1140)	17030049
50	46 7/8" (1191)	17030050
54	50 7/8" (1292)	17030054
62	58 7/8" (1495)	17030062

Jamb		
CN	Length	Beige PN
16	13 7/8" (352)	17030016
24	21 7/8" (556)	17030024
36	33 7/8" (860)	17030036
40	37 7/8" (962)	17030040
44	41 7/8" (1064)	17030044
48	45 7/8" (1165)	17030048
52	49 7/8" (1267)	17030052
56	53 7/8" (1368)	17030056
60	57 7/8" (1470)	17030060
64	61 7/8" (1571)	17030064
68	65 7/8" (1673)	17030068
72	69 7/8" (1775)	17030072
76	73 7/8" (1876)	17030076
84	82 3/8" (2092)	17030084
Lineal	96" (2438)	17030099

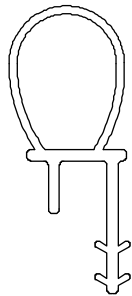

# Check Rail Weather Strip

V3203

## Usage dates:

6/21/2021 to present

Head Jamb				
CN	Length	Beige PN	Black PN	White PN
22	18 15/16" (481)	27007522	27008522	27009522
26	22 15/16" (583)	27007526	27008526	27009526
30	26 15/16" (684)	27007530	27008530	27009530
32	28 15/16" (735)	27007532	27008532	27009532
34	30 15/16" (786)	27007534	27008534	27009534
36	32 15/16" (837)	27007536	27008536	27009536
38	34 15/16" (888)	27007538	27008538	27009538
42	38 15/16" (989)	27007542	27008542	27009542
48	44 15/16" (1141)	27007548	27008548	27009548
54	50 15/16" (1298)	27007554	27008554	27009554

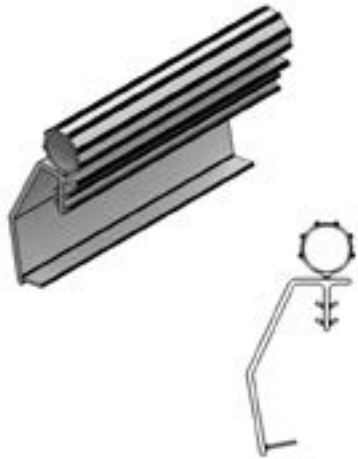

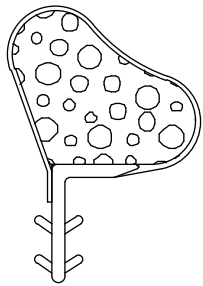

**V025, Sash Weather Strip**

No longer available, refer to instruction 19916006.

Usage: 12/16/2013 to 10/26/2018

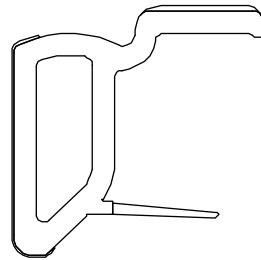

**V2707, Lower Sash Bottom Rail Moulding**

No longer available, replace with V2948.

Refer to instruction 19916006.

Usage: 12/16/2013 to 10/26/2018

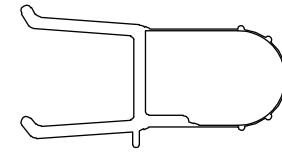

**V2329, Frame Weather Strip, Interior**

No longer available, refer to instruction 19916006.

Usage: 12/16/2013 to 10/26/2018

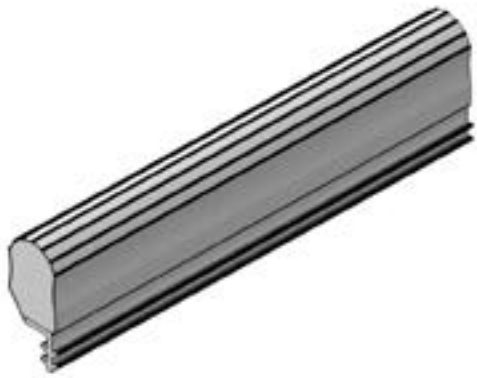

**V2510, Frame Weather Strip, Operator**

No longer available, replace with V3179

Usage: 7/2015 to 11/16/2020

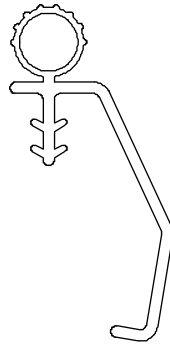

**Check Rail Weather Strip, V1372**

No longer available, replace with current part

Usage dates: 2/2007 to 6/21/2021

## Balance Tube Foam Plug

### Usage dates:

12/16/2013 to present

Color	PN
White	10500104

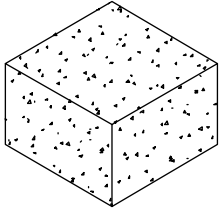

## PVC Foam Tape

NOTE: Used for Stationary Sash Tape

Color	Length	PN
Gray	50' (15 m)	11406228

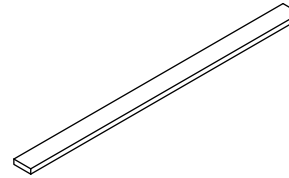

## Flexible Dust Block

NOTE: Check Rail

### Usage dates:

12/16/2013 to present

Color	PN
Gray	15608565



## Header End Plug

### Usage dates:

05/17/2021 to present

Color	LH PN	RH PN
Gray	11860406	11860405

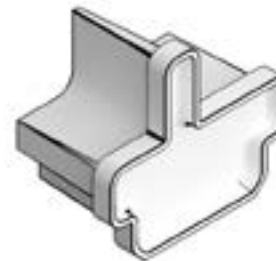

LH shown



## Parting Stop End Cap Gasket

NOTE: For Field Service only

### Usage dates:

May 2016 to present.

Color	PN
Beige	10502060
Gray	10502061

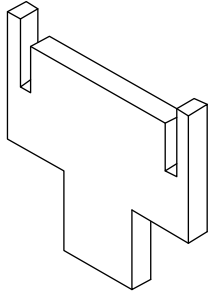

## Balance Tube Channel Plug

NOTE: For Field Service only

Color	PN
Gray	10506363

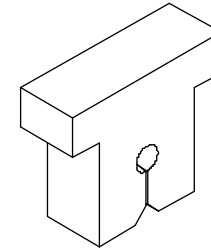

## Balance Tube Dust Block

NOTE: For Field Service only

1 3/8" x 3/8" x 33/64"

### Usage dates:

5/27/2014 to 10/29/2018

Color	PN
Beige	15600011

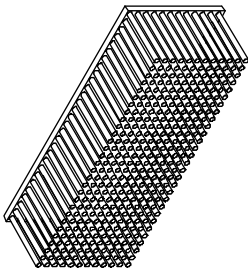

## Balance Tube Dust Block

NOTE: For Field Service only

11/16" x 13/16" x 15/32"

### Usage dates:

12/16/2013 to 5/27/2014

Color	PN
Beige	10500381

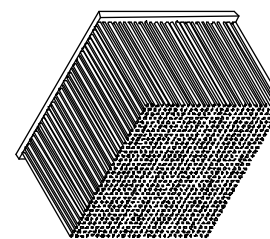

## Balance Tube Channel Plug

NOTE: For Field Service only

### Usage dates:

07/2014 to 10/2018

Color	PN
Gray	10507373

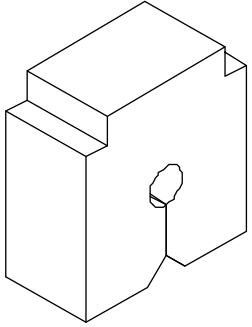

## Jamb Liner Gasket

NOTE: Field Service Only (Refer to instruction 19915736)

### Usage dates:

12/16/2013 to 8/29/2016

PN
10501134



## Screen Replacement

Screens are standard with a white or pebble gray aluminum surround. Standard mesh is Marvin Bright View™. Screens feature plunger type mounting system.

### To order, specify:

1. Specify full or half screen;
2. Size: If there is no existing screen to determine the OM of the screen, use the Daylight Opening to OM of screen conversions shown in the chart. The daylight opening is the measurement of visible glass from the interior of the unit;
3. Color.

### Screen sizes for Elevate Double Hung Insert

Manufactured 12/16/2013 to present

#### Daylight Opening to OM of Screen

Daylight width +3 13/16" (97) = OM width of screen

Daylight height x 2 +6 3/4" (171) = OM height of full screen

Daylight height +4 1/32" (102) = OM height of half screen

**Full Screen**

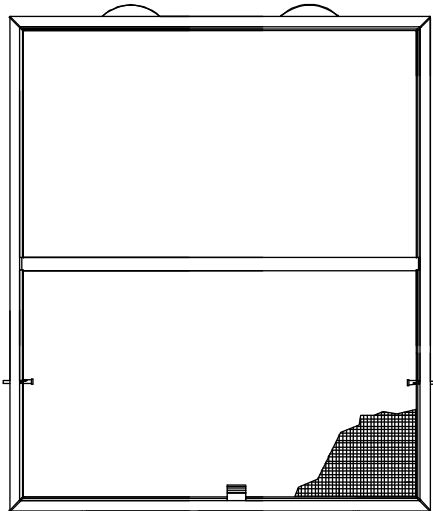

NOTE:

Measure top and bottom sash separately when calculating screen OM height.

**Half Screen**

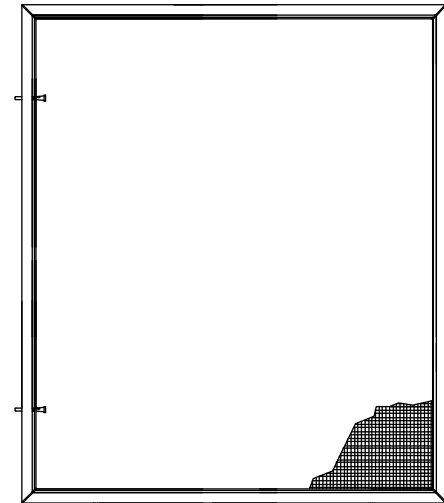

NOTE:

Half screens do feature cross bars

## Screen Plunger Kit

### Includes:

- 1 - Plunger spring
- 1 - Plunger
- 1 - Plunger cap

### Usage dates:

10/25/2021 to present

PN
11851059

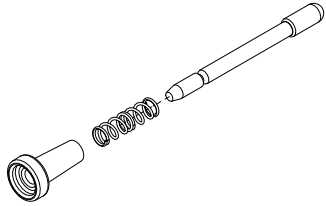

## Leaf Spring

### Usage dates:

2/26/2013 to present

PN
11900897

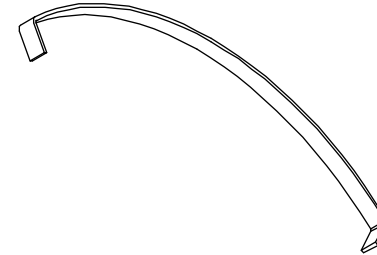

## Flat Bumper

### Usage dates:

12/16/2013 to present

Color	PN
Clear	11860561

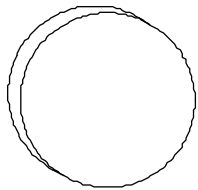

## Half Screen Pile Weather Strip

### Usage dates:

2/26/2013 to present

Color	Length	PN
Gray	Specify length	15619612

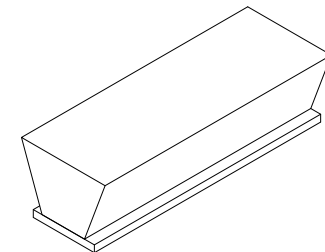

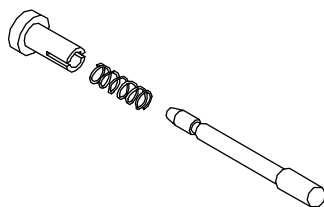

**Plunger and Spring Assembly**

Clear cap, Off White bolt

Used until 10/25/2021, replace with current.

# Sash Replacement

## To order, specify:

1. Top, bottom, or pair of sash;
2. Size;
3. Sash exterior color;
4. Interior finish;
5. Hardware color;
6. Glazing.

## Sash sizes for Elevate Double Hung Insert

### Daylight Opening to OM of sash

Daylight width + 3 1/4" = OM width of sash  
Daylight height + 3 1/4" = OM height of sash

NOTE: Replacement sash is supplied with weather strip and all hardware (with the exception of sash lifts). Sash lifts must be ordered separately. Double Hung Picture replacement sash includes attached sill filler. Daylight opening is the measurement of visible glass from the interior.

NOTE: For bottom replacement sash on units manufactured prior to 10/29/2018, refer to instruction 19916006.

NOTE: Sash is not reglazable; glass replacement will require a new sash.

Top Sash Interior View



Bottom Sash Interior View

