

## Latch Reversal

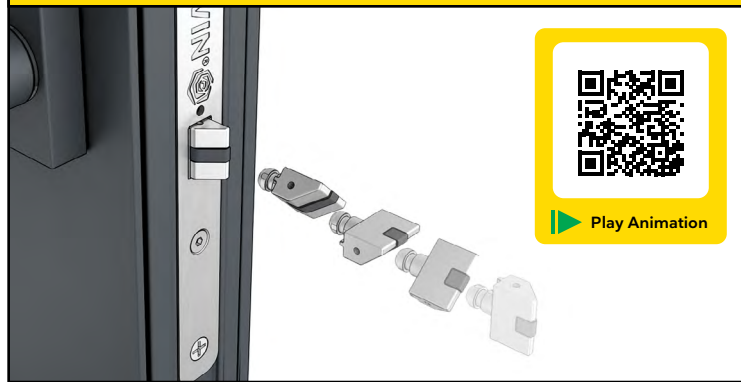

## Handle Installation



# Modern Quickstart Guide

## Swinging Door

### Installation and Mulling Instruction

19916474 - 2022-08-03

MARVIN®

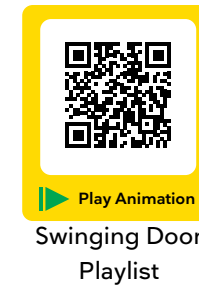

## Hinge Adjustment



## Lock Status Sensor

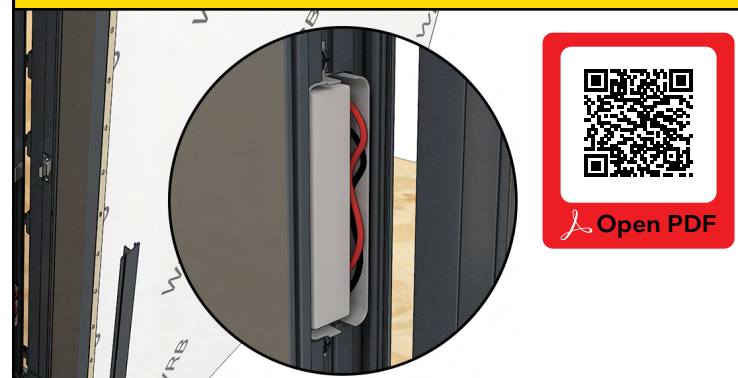

## INTRODUCTION

This instruction is a reference tool for installers to quickly summarize the major steps of an installation and to provide links to the full detailed instructions, videos and other tools. The installer **MUST** read the full instructions in their entirety and rely on that document for all warnings, procedures, and standards.

Download a bar code scanner or QR Code scanner for your mobile device and scan the QR code to open a PDF version of the full instructions. Some sections also have QR codes that link to animated videos and other resources.

 **WARNING! DO NOT lift or move without proper equipment. Read, understand, and follow all lift equipment manufacturers' instructions and safety information.**

## Screen

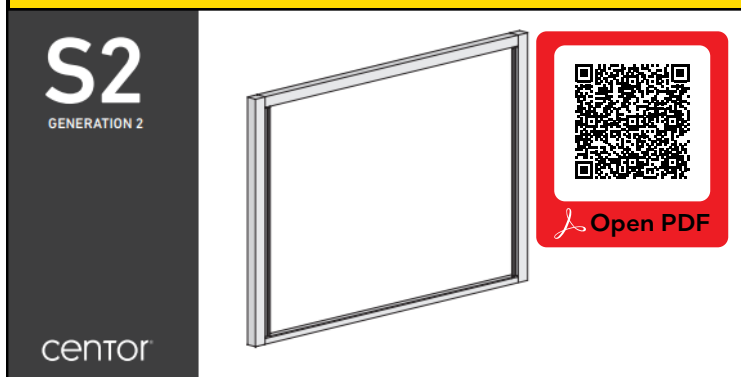

## Screen Sill Riser

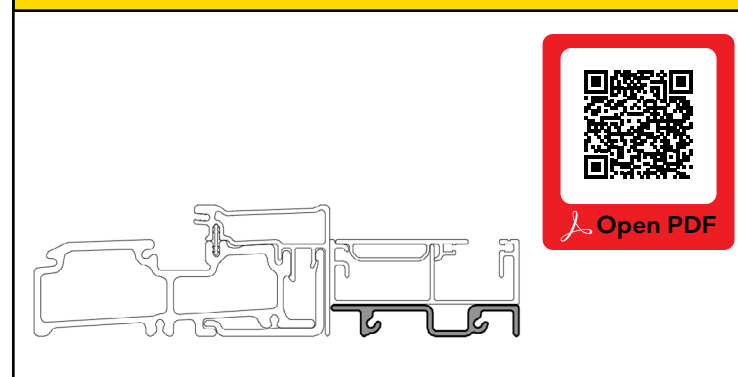

## 1. Site Preparation

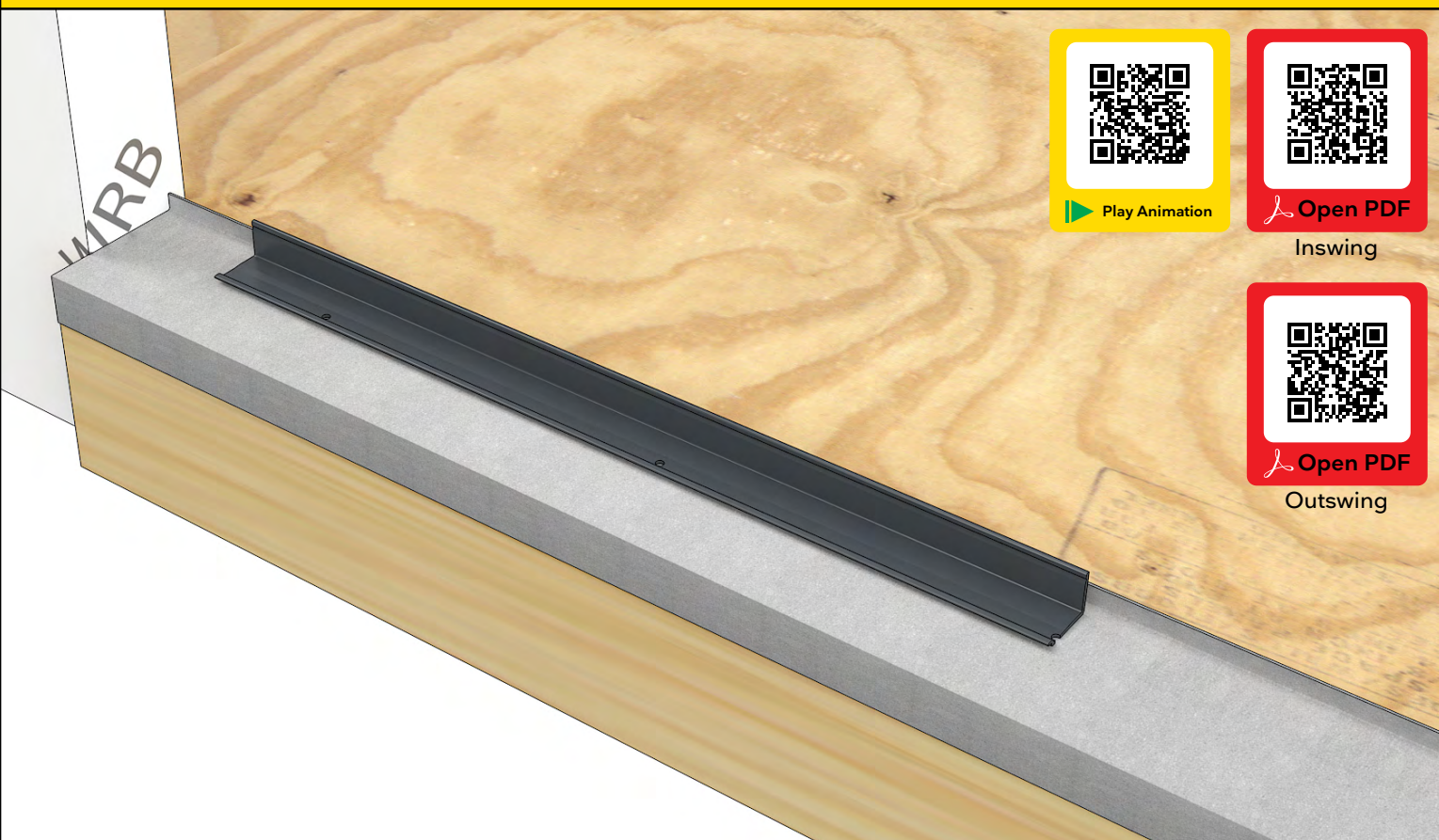



## 2. Frame Assembly

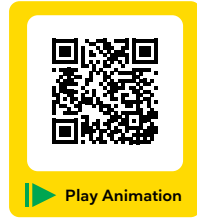
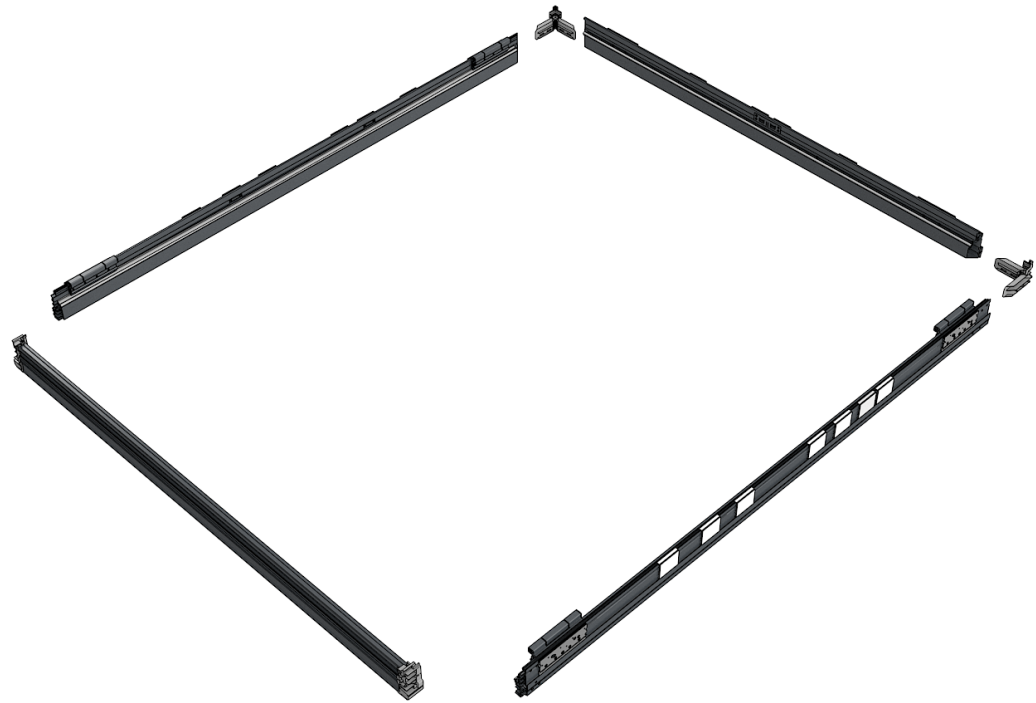

▶ Play Animation  
Inswing

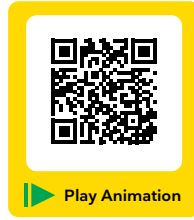

▶ Play Animation  
Outswing

## 3. Frame Installation

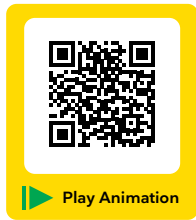
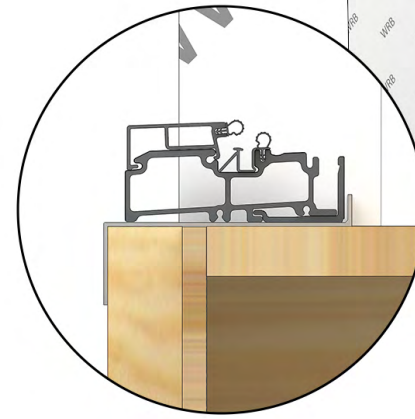

▶ Play Animation  
Inswing

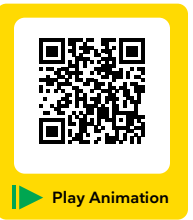

▶ Play Animation  
Outswing

## 4. Mulling

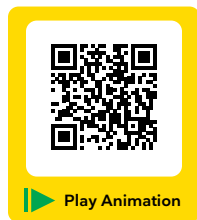

▶ Play Animation  
Standard Mulling

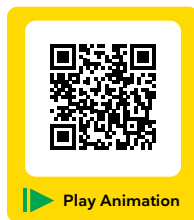

▶ Play Animation  
Structural Flat Steel Mulling

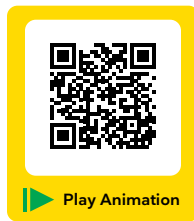

▶ Play Animation  
Structural Tube Steel Mulling

## 5. Panel Installation

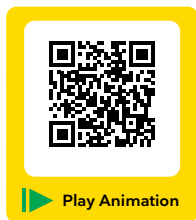

▶ Play Animation  
Inswing

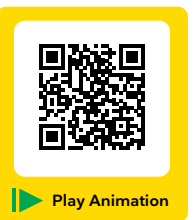

▶ Play Animation  
Outswing