







































































SINGLE HUNG

MO (mm)	1' - 6" (457)	2' - 0" (610)	2' - 6" (762)	2' - 8" (914)	3' - 0" (914)	3' - 6" (1067)	4' - 0" (1219)
RO (mm)	1' - 6" (457)	2' - 0" (610)	2' - 6" (762)	2' - 8" (914)	3' - 0" (914)	3' - 6" (1067)	4' - 0" (1219)
FS (mm)	1' - 5 1/2" (445)	1' - 11 1/2" (597)	2' - 5 1/2" (749)	2' - 7 1/2" (800)	2' - 11 1/2" (902)	3' - 5 1/2" (1054)	3' - 11 1/2" (1207)
DLO (mm)	12 9/16" (319)	18 9/16" (471)	24 9/16" (624)	26 9/16" (675)	30 9/16" (776)	36 9/16" (929)	42 9/16" (1081)
1' - 11 3/4" (603) 2' - 0" (610) 2' - 6" (762) 2' - 5 1/2" (749) 1' - 11 1/2" (597) 8 5/16" (211)	 ESSH1620	 ESSH2020	 ESSH2620	 ESSH2820	 ESSH3020	 ESSH3620	 ESSH4020
2' - 5 3/4" (756) 2' - 6" (762) 2' - 5 1/2" (749) 11 5/16" (287)	 ESSH1626	 ESSH2026	 ESSH2626	 ESSH2826	 ESSH3026	 ESSH3626	 ESSH4026
2' - 11 3/4" (908) 3' - 0" (914) 3' - 11 1/2" (902) 14 5/16" (363)	 ESSH1630	 ESSH2030	 ESSH2630	 ESSH2830	 ESSH3030	 ESSH3630	 ESSH4030
3' - 5 3/4" (1060) 3' - 6" (1067) 3' - 5 1/2" (1054) 17 5/16" (440)	 ESSH1636	 ESSH2036	 ESSH2636	 ESSH2836	 ESSH3036	 ESSH3636	 ESSH4036
3' - 11 3/4" (1213) 4' - 0" (1219) 4' - 11 1/2" (1207) 20 5/16" (516)	 ESSH1640	 ESSH2040	 ESSH2640	 ESSH2840	 ESSH3040	 ESSH3640	 ESSH4040
4' - 5 3/4" (1365) 4' - 6" (1372) 4' - 5 1/2" (1359) 23 5/16" (592)	 ESSH1646	 ESSH2046	 ESSH2646	 ESSH2846	 ESSH3046	 ESSH3646	 ESSH4046
4' - 11 3/4" (1518) 5' - 0" (1524) 4' - 11 1/2" (1511) 26 5/16" (668)	 ESSH1650	 ESSH2050	 ESSH2650	 ESSH2850	 ESSH3050 E	 ESSH3650 E	 ESSH4050 E
5' - 5 3/4" (1670) 5' - 6" (1676) 5' - 5 1/2" (1664) 29 5/16" (744)	 ESSH1656	 ESSH2056	 ESSH2656	 ESSH2856	 ESSH3056 E	 ESSH3656 E	 ESSH4056 E
5' - 11 3/4" (1822) 6' - 0" (1829) 5' - 11 1/2" (1816) 32 5/16" (821)	 ESSH1660	 ESSH2060	 ESSH2660 E	 ESSH2860 E	 ESSH3060 E	 ESSH3660 E	 ESSH4060 E
6' - 5 3/4" (1975) 6' - 6" (1981) 6' - 5 1/2" (1969) 35 5/16" (897)	 ESSH1666	 ESSH2066	 ESSH2666 E	 ESSH2866 E	 ESSH3066 E	 ESSH3666 E	 ESSH4066 E



















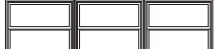





























MARVIN ESSENTIAL™ COLLECTION
SINGLE HUNG

2 Wide

MO (mm)	3' - 0" (914)	4' - 0" (1219)	5' - 0" (1524)	5' - 4" (1626)	6' - 0" (1829)	7' - 0" (2134)	8' - 0" (2438)
RO (mm)	3' - 0" (914)	4' - 0" (1219)	5' - 0" (1524)	5' - 4" (1626)	6' - 0" (1829)	7' - 0" (2134)	8' - 0" (2438)
FS (mm)	2' - 11 1/2" (902)	3' - 11 1/2" (1207)	4' - 11 1/2" (1511)	5' - 3 1/2" (1613)	5' - 11 1/2" (1816)	6' - 11 1/2" (2121)	7' - 11 1/2" (2426)
1' - 11" 3/4" (603)							
2' - 5 3/4" (766)							
2' - 11 3/4" (908)							
3' - 5 3/4" (1060)							
3' - 11 3/4" (1213)							
4' - 5 3/4" (1365)							
4' - 11 3/4" (1518)							
5' - 5 3/4" (1670)							
5' - 11 3/4" (1822)							
6' - 5 3/4" (1975)							

SINGLE HUNG





















3 Wide

MO (mm)	4' - 6" (1372)	6' - 0" (1829)	7' - 6" (2286)	8' - 0" (2438)	9' - 0" (2743)
RO (mm)	4' - 6" (1372)	6' - 0" (1829)	7' - 6" (2286)	8' - 0" (2438)	9' - 0" (2743)
FS (mm)	4' - 5 1/2" (1359)	5' - 11 1/2" (1816)	7' - 5 1/2" (2273)	7' 11 1/2" (2426)	8' - 11 1/2" (2731)
1' - 11" 3/4" (603) 2' - 0" (610) 1' - 11 1/2" (597)	 ESSH1620	 ESSH2020	 ESSH2620	 ESSH2820	 ESSH3020
2' - 5 3/4" (756) 2' - 6" (762) 2' - 5 1/2" (749)	 ESSH1626	 ESSH2026	 ESSH2626	 ESSH2826	 ESSH3026
2' - 11 3/4" (908) 3' - 0" (914) 2' - 11 1/2" (902)	 ESSH1630	 ESSH2030	 ESSH2630	 ESSH2830	 ESSH3030
3' - 5 3/4" (1060) 3' - 6" (1067) 3' - 5 1/2" (1054)	 ESSH1636	 ESSH2036	 ESSH2636	 ESSH2836	 ESSH3036
3' - 11 3/4" (1213) 4' - 0" (1219) 3' - 11 1/2" (1207)	 ESSH1640	 ESSH2040	 ESSH2640	 ESSH2840	 ESSH3040
4' - 5 3/4" (1365) 4' - 6" (1372) 4' - 5 1/2" (1359)	 ESSH1646	 ESSH2046	 ESSH2646	 ESSH2846	 ESSH3046
4' - 11 3/4" (1518) 5' - 0" (1524) 4' - 11 1/2" (1511)	 ESSH1650	 ESSH2050	 ESSH2650	 ESSH2850	 ESSH3050 E
5' - 5 3/4" (1670) 5' - 6" (1676) 5' - 5 1/2" (1664)	 ESSH1656	 ESSH2056	 ESSH2656	 ESSH2856	 ESSH3056 E
5' - 11 3/4" (1822) 6' - 0" (1829) 5' - 11 1/2" (1816)	 ESSH1660	 ESSH2060	 ESSH2660 E	 ESSH2860 E	 ESSH3060 E
6' - 5 3/4" (1975) 6' - 6" (1981) 6' - 5 1/2" (1969)	 ESSH1666	 ESSH2066	 ESSH2666 E	 ESSH2866 E	 ESSH3066 E

SINGLE HUNG

4 Wide

MO (mm)	6' - 0" (1829)	8' - 0" (2438)
RO (mm)	6' - 0" (1829)	8' - 0" (2438)
FS (mm)	5' - 11 1/2" (1816)	7' - 11 1/2" (2426)

1' - 11 3/4" (603) 1' - 0" (610) 2' - 0" (610) 1' - 11 1/2" (697)	 ESSH1620	 ESSH2020
2' - 5 3/4" (756) 2' - 6" (762) 2' - 5 1/2" (749)	 ESSH1626	 ESSH2026
2' - 11 3/4" (908) 3' - 0" (914) 2' - 11 1/2" (902)	 ESSH1630	 ESSH2030
3' - 5 3/4" (1060) 3' - 6" (1067) 3' - 5 1/2" (1054)	 ESSH1636	 ESSH2036
3' - 11 3/4" (1213) 4' - 0" (1219) 3' - 11 1/2" (1207)	 ESSH1640	 ESSH2040
4' - 5 3/4" (1365) 4' - 6" (1372) 4' - 5 1/2" (1359)	 ESSH1646	 ESSH2046
4' - 11 3/4" (1518) 5' - 0" (1524) 4' - 11 1/2" (1511)	 ESSH1650	 ESSH2050
5' - 5 3/4" (1670) 5' - 6" (1676) 5' - 5 1/2" (1664)	 ESSH1656	 ESSH2056
5' - 11 3/4" (1822) 6' - 0" (1829) 5' - 11 1/2" (1816)	 ESSH1660	 ESSH2060
6' - 5 3/4" (1975) 6' - 6" (1981) 6' - 5 1/2" (1969)	 ESSH1666	 ESSH2066

GBG available in standard Rectangular lite cut, shown. Other GBG lite cuts shown on page 3.

E = These windows (in equal sash) meet National Egress Codes for fire evacuation. Local codes may differ.

Details and Elevations not to scale.

Available in equal, cottage, and reverse cottage sash configurations. Cottage and reverse cottage sash configurations are not available on 20 call number heights.

Obscure Glass option available on all units.

Units may optionally include a window opening control device tested to ASTM F2090-10, which can be released from the inside without the use of a key, tool, special knowledge, or force greater than that required for normal unit operation.

Special sized units available within product size matrix. See your Marvin retailer.

See page 52 for specific PG Ratings.

For further details and drawings visit the 'Tools and Documents' section at Marvin.com.

MULTIPLE ASSEMBLIES

Multiple assemblies can be factory mullied.

MAXIMUM ROUGH OPENING not to exceed 114" x 78".

Maximum up to 6 units wide by 1 unit high.

MAXIMUM ROUGH OPENING not to exceed 96" x 96".

Maximum up to 5 units wide by 5 units high.

Field mull kits are available. Structural mullion reinforcement is required for some assemblies.

Please consult your local Marvin representative for more information.

SINGLE HUNG - Transoms and Multiple Assemblies

Transom Muller Over Single Hung

MO (mm)	2' - 6" (762)
RO (mm)	2' - 6" (762)
FS (mm)	2' - 5 1/2" (749)

Transom Muller Over Single Hung 2 Wide

MO (mm)	5' - 0" (1524)
RO (mm)	5' - 0" (1524)
FS (mm)	4' - 11 1/2" (1511)

Single Hung Flankers with Center Picture*

MO (mm)	10' - 0" (3048)
RO (mm)	10' - 0" (3048)
FS (mm)	9' - 11 1/2" (3035)

Single Hung Flankers with Center Operator

MO (mm)	7' - 6" (2286)
RO (mm)	7' - 6" (2286)
FS (mm)	7' - 5 1/2" (2273)

Construction Details

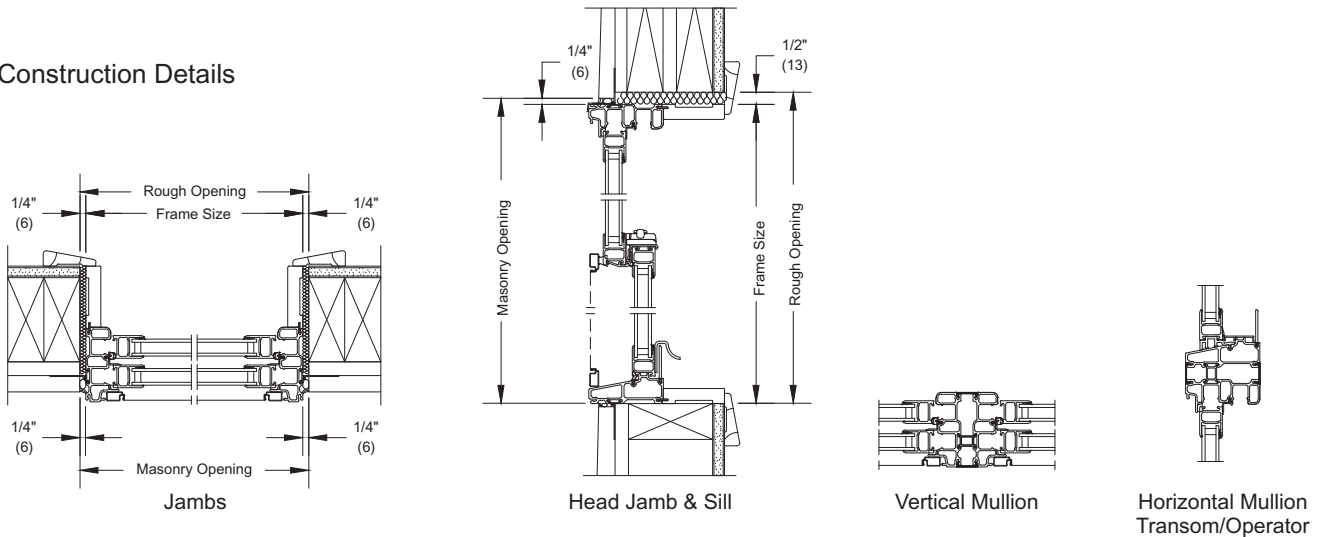

E = These windows (in equal sash) meet National Egress Codes for fire evacuation. Local codes may differ.

* This product is only available field muller.

Details and Elevations not to scale.

Available in equal, cottage, and reverse cottage sash configurations. Cottage and reverse cottage sash configurations are not available on 20 and 66 call number heights.

Obscure Glass option available on all units.

Units may optionally include a window opening control device tested to ASTM F2090-10, which can be released from the inside without the use of a key, tool, special knowledge, or force greater than that required for normal unit operation.

Special sized units available within product size matrix. See your Marvin retailer.

See page 52 for specific PG Ratings.

MULTIPLE ASSEMBLIES

Multiple assemblies can be factory muller.

MAXIMUM ROUGH OPENING not to exceed 114" x 78".
Maximum up to 6 units wide by 1 unit high.

MAXIMUM ROUGH OPENING not to exceed 96" x 96".
Maximum up to 5 units wide by 5 units high.

Field mull kits are available. Structural mullion reinforcement is required for some assemblies.

Please consult your local Marvin representative for more information.