



Ultimate Bi-Fold Door

Ultimate Wood Bi-Fold Door

Contents

Replacement Parts

Specifications and technical data are subject to change without notice.

Numbers listed in () parentheses are metric equivalents in millimeters rounded to the nearest whole number.

Suggested fasteners are not included and must be ordered separately.

Illustrations are not to scale.

Product History.....	2
Part Identification - Ultimate Bi-Fold Door.....	3
Part Identification - Ultimate Wood Bi-Fold Door.....	4
Configuration - Bi-Parting.....	5
Configuration - Unidirectional.....	6
Installation Parts.....	7
Traditional Handle.....	8
Contemporary Handle.....	12
Handle - Keyed Cylinder.....	17
Panel Handle.....	18
Locking Hardware.....	19
Lock Status Sensor.....	22
Hinges.....	23
Operators.....	24
Miscellaneous Parts.....	26
Aluminum Parts.....	28
Vinyl Parts.....	29
Wood Parts.....	30
Weather Strip.....	31
Weather Strip - Discontinued - No Longer Available (NA).....	34
Panel Replacement.....	35
Screen Handing Diagram.....	36
Retractable Screen SE4 Parts - Configured in OMS.....	37
Retractable Screen SE4 Parts.....	38
Scenic Door Sliding Screen Discontinued Parts Pre 4/27/20 - (LA).....	41

Produced	Unit Type	Features and Changes
2017	Ultimate Bi-Fold Door	04/24/2017 – Introduced redesigned Ultimate Bi-Fold Door. 08/28/2017 – Added certified IZ3 option. Added Black as color option for the Scenic Door Ultimate Sliding Screen 12/18/2017 – Added availability of Lock Status Sensor.
2018	Ultimate Wood Bi-Fold Door	02/26/2018 – Introduced redesigned Wood Ultimate Outswing Bi-Fold Door.
2019	Ultimate Bi-Fold Door Ultimate Wood Bi-Fold Door	04/29/2019– V1910 weather strip was replaced with V3020 panel weather strip and V3019 frame weatherstrip.
2020	Ultimate Bi-Fold Door Ultimate Wood Bi-Fold Door	04/27/2020 – Scenic Door Ultimate Sliding Screen transitions to the SE4 Retractable Screen.
2023	Ultimate Bi-Fold Door Ultimate Wood Bi-Fold Door	10/30/2023: An ERS coating became available as a standard option for current Triple Pane offerings. See Product Bulletin 904 for more details.

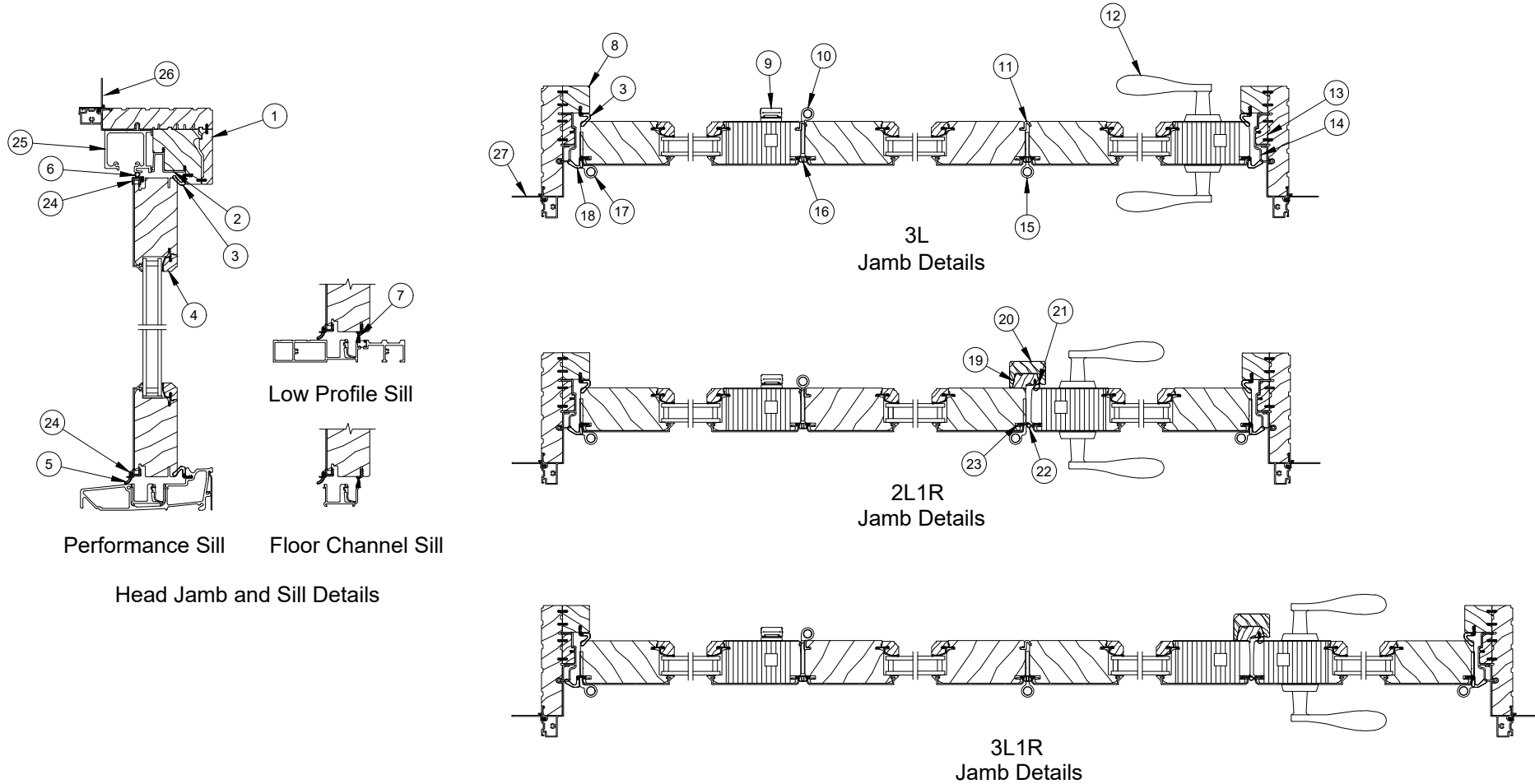

- 1. Head Jamb Part Stop, W12711
- 2. Shoot Bolt Channel, V2683
- 3. Frame Weather Strip, V3019
- 4. Ogee Glazing Cap, W12367
- 5. Frame Weather Strip, V1194
- 6. Weather Strip, Top Rail Cap, V2475
- 7. 1/2" Pile Offset Weather Strip, V2791
- 8. Jamb Part Stop, W12713
- 9. Interior Panel Handle
- 10. Offset Hinge
- 11. Panel Weather Strip, V1897

- 12. Traditional Handle
- 13. Frame Cover Support*
Short, W12750
Mid, W12752 (shown)
Tall, W12751
* See Installation Instruction
PN 19915742 for usage.
- 14. Frame Cover, V2690
- 15. Straight Hinge
- 16. Panel Weather Strip, V2726
- 17. Jamb Pivot/Hinge

- 18. Panel Weather Strip, V3020
- 19. Astragal Base, W12709
- 20. Ogee Astragal Cap, W12708
- 21. Bulb Weather Strip (Astragal Base), V796
- 22. Stile Weather Strip, V020
- 23. Weather Strip, Inactive, V1706
- 24. Rail Cap, A3052
- 25. Head Track, A3113
- 26. Head Jamb Nailing Fin, V119
- 27. Jamb Nailing Fin, V104

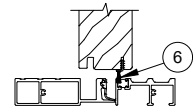
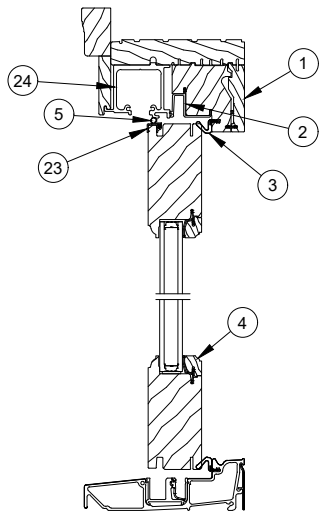

Low Profile Sill

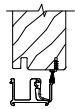

Floor Channel Sill

Performance Sill

Head Jamb and Sill Details

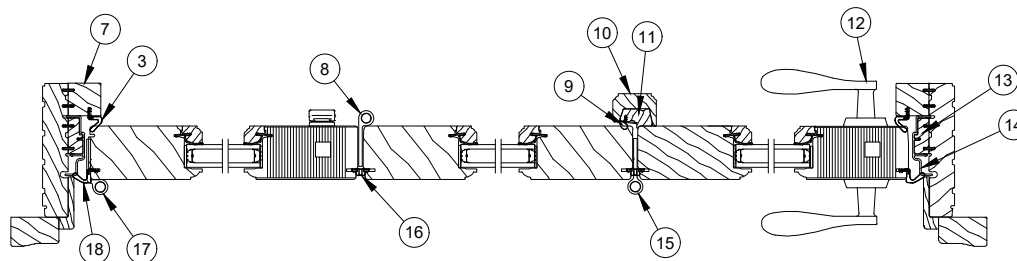

3L
Jamb Details

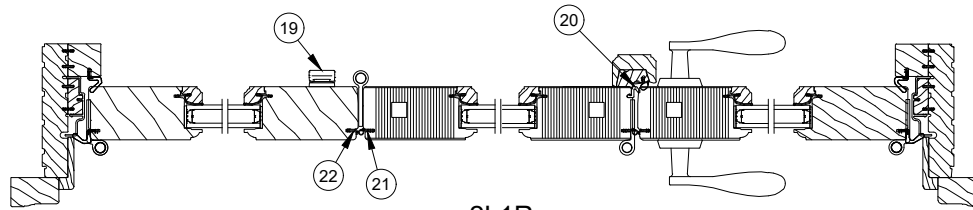

2L1R
Jamb Details

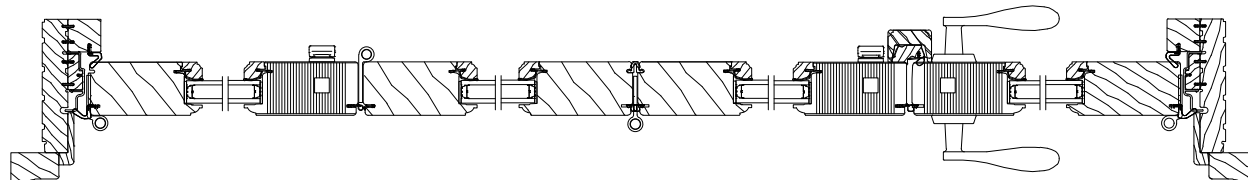

3L1R
Jamb Details

1. Head Jamb Part Stop, W12711
2. Shoot Bolt Channel, V2683
3. Frame Weather Strip, V3019
4. Ogee Glazing Cap, W12367
5. Weather Strip, Top Rail Cap, V2475
6. 1/2" Pile Offset Weather Strip, V2791
7. Jamb Part Stop, W12713
8. Offset Hinge
9. Bulb Weather Strip (Astragal Base), V796
10. Ogee Astragal Cap, W12708
11. Astragal Base, W12709

12. Traditional Handle
13. *Frame Cover Support
Short, W12750
Mid, W12752 (shown)
Tall, W12751
* See Installation Instruction
PN 19915742 for usage.
14. Frame Cover, V2690
15. Straight Hinge

16. Panel Weather Strip, V2726
17. Jamb Pivot/Hinge
18. Panel Weather Strip, V3020
19. Interior Panel Handle
20. Panel Weather Strip, V1897
21. Stile Weather Strip, V020
22. Weather Strip, Inactive, V1706
23. Rail Cap, A3052
24. Head Track, A3229

Bi-Parting - Unequal Units

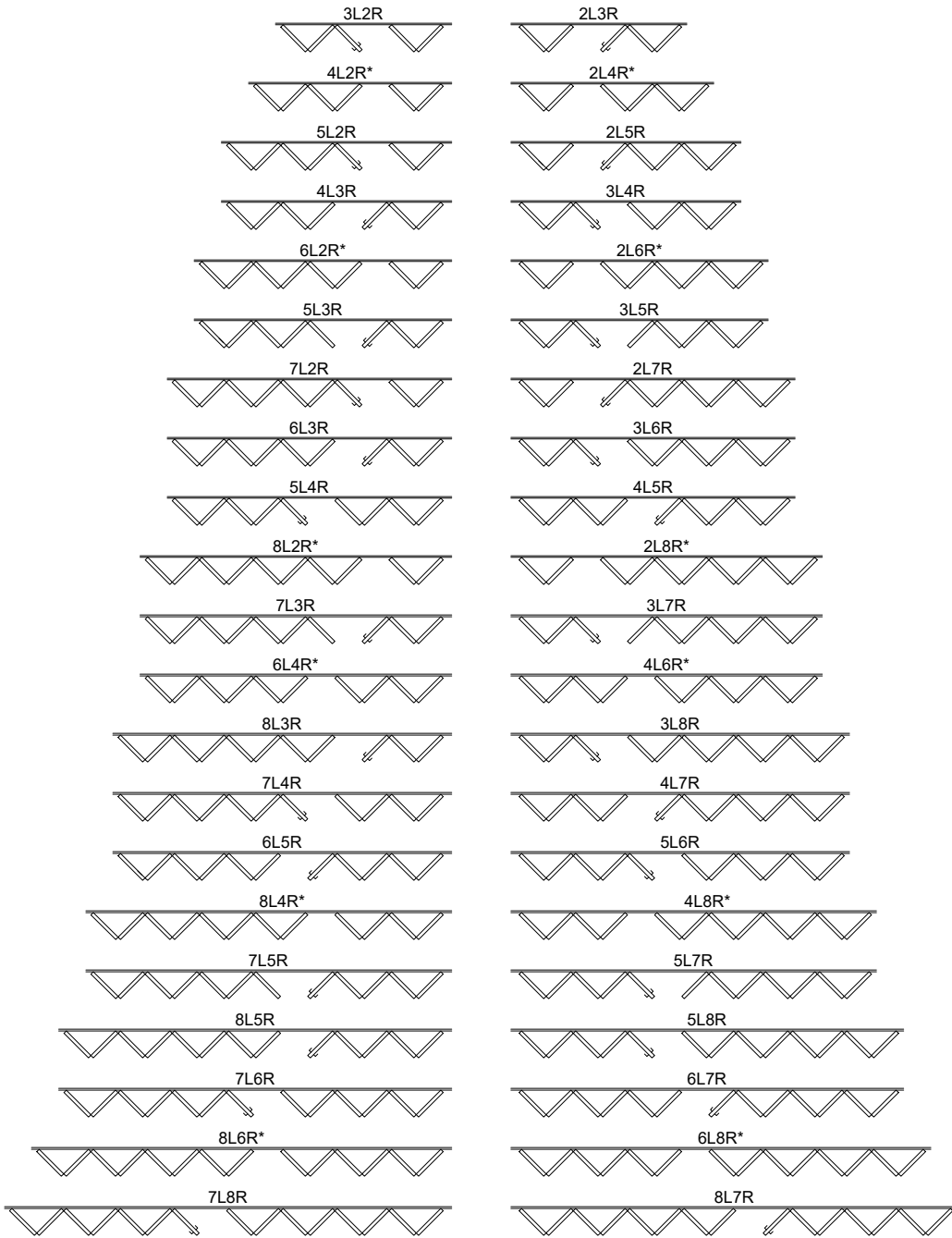

Bi-Parting - Equal Units

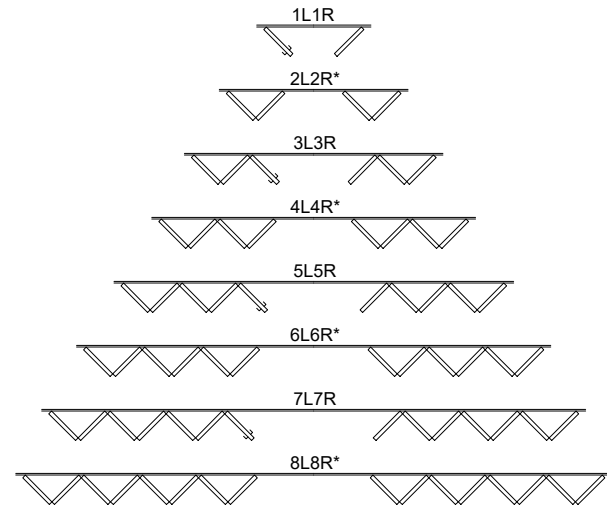

NOTE: Not accessible from the exterior if no handle is shown.

Stationary Unit



Uni-directional Left or Right Units

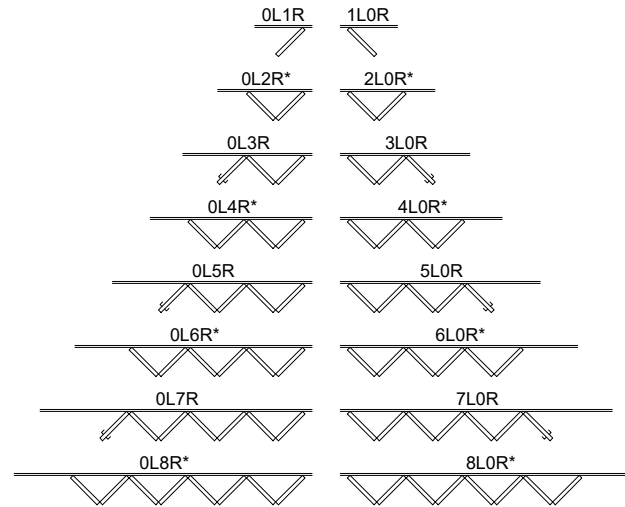

Uni-directional Left or Right Units with Operating Panel/s

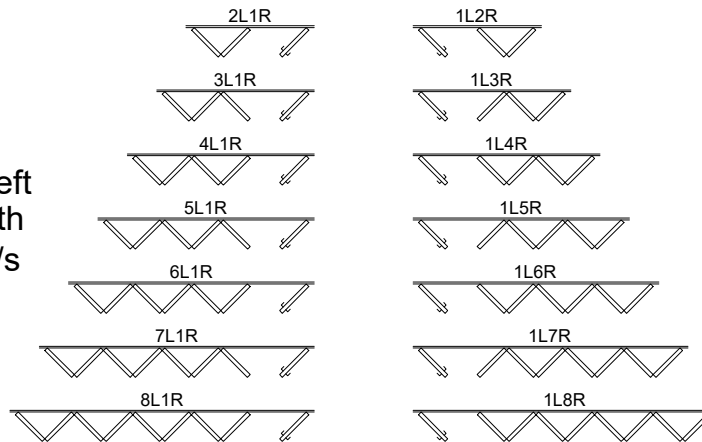

NOTE: Not accessible from the exterior if no handle is shown.

Frame Corner Key

NOTE: Used on Ultimate units only

Color	PN
Black	11869838

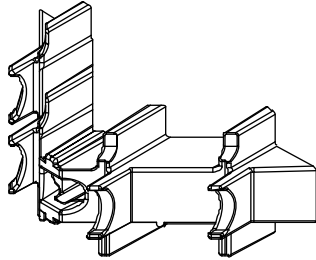

Construction Handle

Color	PN
Black	10830451

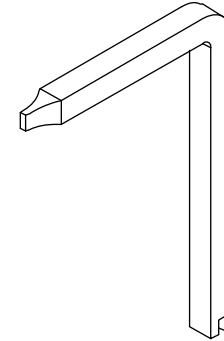

Handle Assembly, Active, Keyed

Mortise Lock and Multi-Point Lock Systems (Schlage “C” Keyway)

Includes:

- 1 - Interior lever with spindle, escutcheon plate and hardware
- 1 - Exterior lever with escutcheon plate and hardware
- 1 - Thumb turn with hardware (A)
- 1 - Keyed cylinder with housing and hardware (B)
- 1 - Exterior escutcheon plate gasket
- 2 - Lug Seal (C)
- 1 - Two piece spindle, 5.06” w/2 1/4” panel (D)
- 2 - #10–32 x 2 5/8” Phillips oval head machine screws (w/2 1/4” Panel) (E)
- 2 - Keys

Color	PN
White	21448119
Oil Rubbed Bronze	21448111
Oil Rubbed Bronze PVD	21448118
Satin Nickel PVD	21448110
Dark Bronze	21448120
Matte Black	21448131

Thumb Turn, No Tailpiece	
Color	PN
White	10148489
Oil Rubbed Bronze	10148481
Oil Rubbed Bronze PVD	10148485
Satin Nickel PVD	10148487
Dark Bronze	10148489
Matte Black	10148480

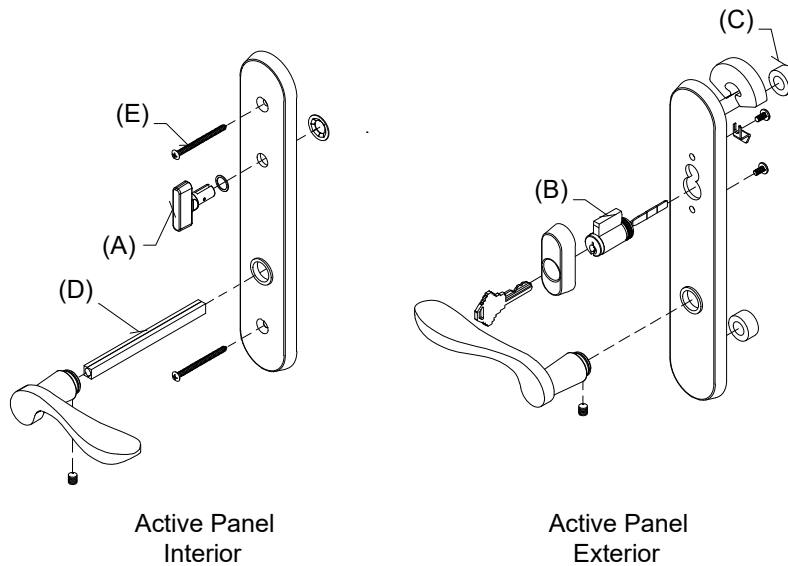

Handle Assembly, Active, Non-Keyed

Mortise Lock and Multi-Point Lock Systems (Schlage "C" Keyway)

Includes:

- 2 - Levers
- 2 - Lever bushings (D)
- 2 - Lug seals (C)
- 1 - Interior escutcheon
- 1 - Exterior escutcheon
- 1 - Thumb turn with actuator/tail piece (B)
- 1 - Two piece spindle, 5.06" w/2 1/4" panel (A)
- 2 - #10-32 x 2 5/8" Phillips oval head machine screws (w/2 1/4" Panel) (E)
- 2 - Set screws
- 1 - Allen wrench
- 1 - Installation instruction

Handle Assembly - 2 1/4" Panel	
Color	PN
White	21448176
Oil Rubbed Bronze	21448172
Oil Rubbed Bronze PVD	21448170
Satin Nickel PVD	21448181
Dark Bronze	21448178
Matte Black	21448179

Thumb Turn with Tail Piece/Actuator (for non-keyed handle)	
Color	PN
White	10148501
Oil Rubbed Bronze	10148493
Oil Rubbed Bronze PVD	10148497
Satin Nickel PVD	10148499
Dark Bronze	10148491
Matte Black	10148492

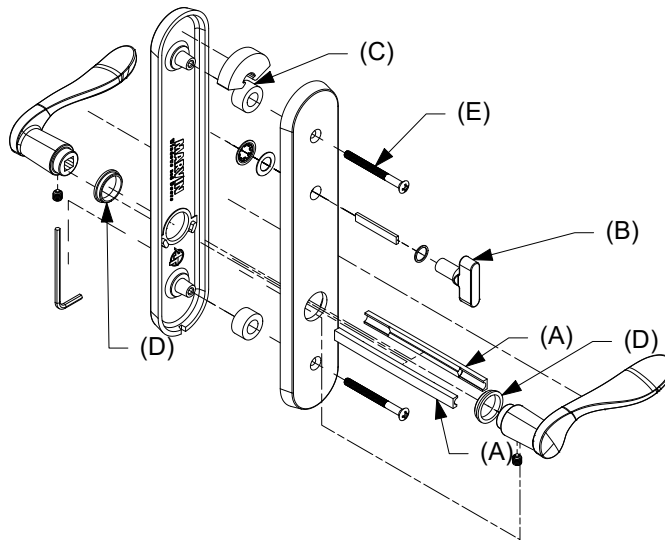

Handle Assembly, Inactive/Dummy

Includes:

- 1 - Interior lever with spindle, escutcheon plate and hardware
- 1 - Exterior lever with escutcheon plate and hardware
- 1 - Exterior escutcheon plate gasket
- 1 - Exterior escutcheon plate
- 2 - Lug seals (A)
- 1 - Two piece spindle, 5.06" (w/2 1/4" panel) (B)
- 2 - #10-32 x 2 5/8" Phillips oval head machine screws (w/2 1/4" Panel) (C)

Color	PN
White	21448150
Oil Rubbed Bronze	21448154
Oil Rubbed Bronze PVD	21448145
Satin Nickel PVD	21448133
Dark Bronze	21448162
Matte Black	21448163

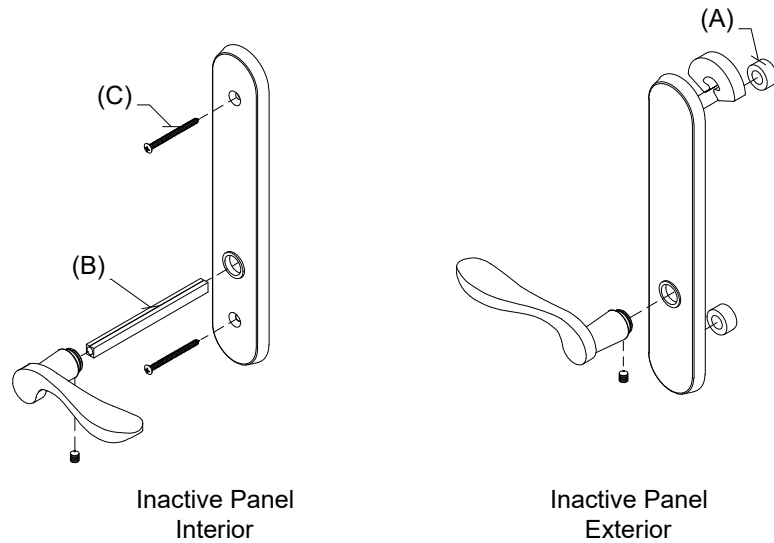

#10-32 x 2 5/8" Phillips Oval Head Machine Screw

NOTE: Dark Bronze screws are used for Oil Rubbed Bronze PVD.

Color	PN
White	11800240
Oil Rubbed Bronze PVD	11800236
Satin Nickel PVD	11800238
Dark Bronze	11800231
Oil Rubbed Bronze	11800232
Matte Black	11800179

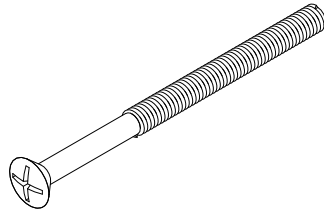

Lug Seal

PN
00142046

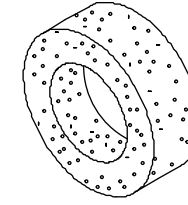

Spindle

Includes:

- 1 - 2 pc. Spindle
- 2 - Set screws

Length	PN
5.06"	18900393

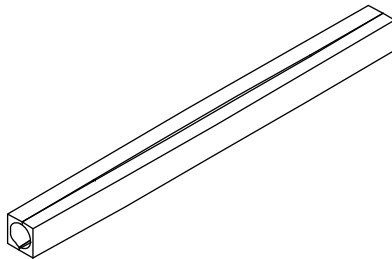

Lever Bushing, Traditional

Color	PN
Clear	02062201
Gray	10148448
Gold	10148447
Natural	02062202
Black	10148020

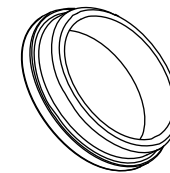

Contemporary Handle, Exterior, Active, Keyed

Includes:

- 1 - Handle
- 1 - Exterior escutcheon with bushing
- 1 - Keyed cylinder
- 2 - Lug seals
- 1 - Spring cartridge
- 1 - Set screw
- 1 - Installation instruction
- 1 - Hex wrench

LH Outswing uses RH PN RH Outswing uses LH PN		
Color	LH PN	RH PN
Matte Black	11870120	11870112
Satin Nickel PVD	11870122	11870114
Oil Rubbed Bronze PVD	11870124	11870116
Dark Bronze	11870126	11870118

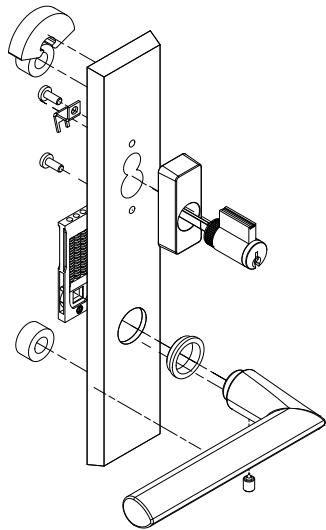

LH shown

Contemporary Handle, Interior, Active, Keyed

Includes:

- 1 - Handle
- 1 - Interior escutcheon with bushings
- 1 - Spring cartridge
- 1 - Thumb turn
- 2 - Machine screws, 2 1/4" Doors
- 2 - Machine screws, 1 3/4" Doors
- 1 - Split spindle, 2 1/4" Doors
- 1 - Split spindle, 1 3/4" Doors
- 1 - Set screw
- 1 - Installation instruction
- 1 - Hex wrench

LH Outswing uses LH PN RH Outswing uses RH PN		
Color	LH PN	RH PN
Matte Black	11870104	11870097
Satin Nickel PVD	11870106	11870098
Oil Rubbed Bronze PVD	11870108	11870100
Dark Bronze	11870110	11870102

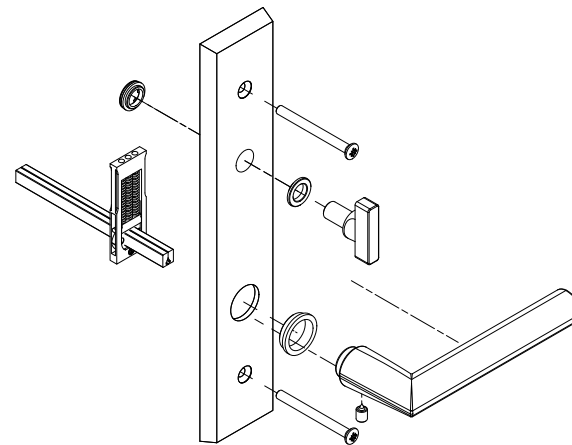

RH shown

Contemporary Handle, Interior, Active, Non-Keyed

Includes:

- 1 - Handle
- 1 - Interior escutcheon with bushings
- 1 - Spring cartridge
- 1 - Thumb turn
- 2 - Machine screws, 2 1/4" Doors
- 2 - Machine screws, 1 3/4" Doors
- 1 - Split spindle, 2 1/4" Doors
- 1 - Split spindle, 1 3/4" Doors
- 1 - Set screw
- 1 - Installation instruction
- 1 - Hex wrench

LH Outswing uses LH PN RH Outswing uses RH PN		
Color	LH PN	RH PN
Matte Black	11870136	11870128
Satin Nickel PVD	11870138	11870130
Oil Rubbed Bronze PVD	11870139	11870132
Dark Bronze	11870143	11870133

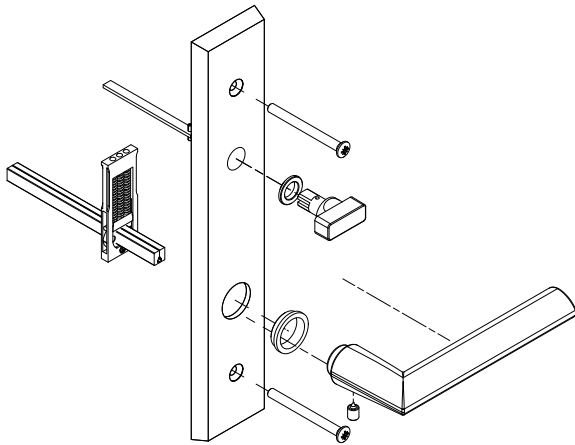

RH shown

Contemporary Handle, Exterior, Non-Keyed, Inactive/Dummy

Includes:

- 1 - Handle
- 1 - Exterior escutcheon with bushings
- 2 - Lug seals
- 1 - Fixing plate
- 1 - Set screw
- 1 - Installation instruction
- 1 - Hex wrench

LH Outswing uses RH PN RH Outswing uses LH PN		
Color	LH PN	RH PN
Matte Black	11870153	11870145
Satin Nickel PVD	11870154	11870146
Oil Rubbed Bronze PVD	11870156	11870148
Dark Bronze	11870158	11870149

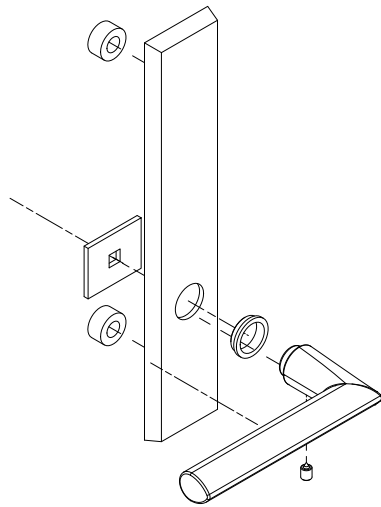

LH shown

Contemporary Handle, Interior, Inactive/Dummy

Includes:

- 1 - Handle
- 1 - Escutcheon with bushing
- 1 - Dummy fixing plate
- 1 - Spring cartridge
- 2 - Machine screws, 2 1/4" Doors
- 2 - Machine screws, 1 3/4" Doors
- 1 - Split spindle, 2 1/4" Doors
- 1 - Split spindle, 1 3/4" Doors
- 1 - Set screw
- 1 - Installation instruction
- 1 - Hex wrench

LH Outswing uses LH PN RH Outswing uses RH PN		
Color	LH PN	RH PN
Matte Black	11870169	11870160
Satin Nickel PVD	11870171	11870162
Oil Rubbed Bronze PVD	11870172	11870164
Dark Bronze	11870174	11870166

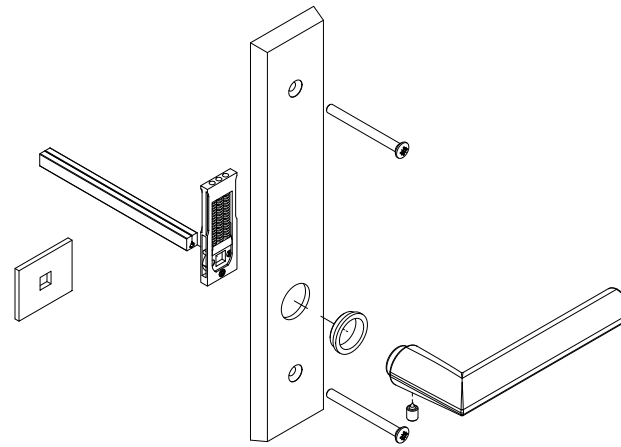

RH shown

Thumb Turn, Contemporary

For Keyed Handle

Includes:

- Thumb Turn Washer
- Thumb Turn Push Nut

No Tail Piece/Actuator (for keyed handle)	
Color	PN
Oil Rubbed Bronze PVD	10148485
Satin Nickel PVD	10148487
Dark Bronze	10148479
Matte Black	10148480

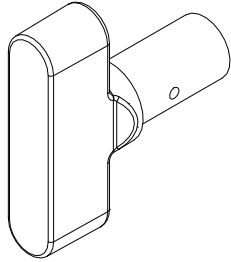

Thumb Turn, Contemporary with Actuator/Tail Piece

For Non-Keyed Handle

Includes:

- Actuator/Tailpiece
- Thumb Turn Washer
- Thumb Turn Push Nut

With Tail Piece/Actuator (for non-keyed handle)	
Color	PN
Oil Rubbed Bronze PVD	10148497
Satin Nickel PVD	10148499
Dark Bronze	10148491
Matte Black	10148492

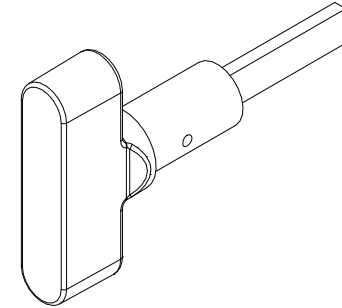

M5 x 65mm Phillips Oval Head Machine Screw

Color	PN
Dark Bronze	10148455
Oil Rubbed Bronze PVD	10148456
Satin Nickel PVD	10148457
Matte Black	11800694

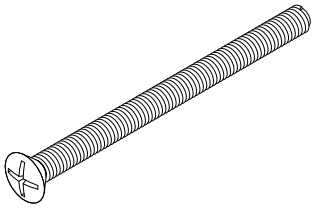

3/4" Handle Extension

Color	PN
Dark Bronze	10148420
Oil Rubbed Bronze PVD	10148421
Satin Nickel PVD	10148422
Matte Black	10148445

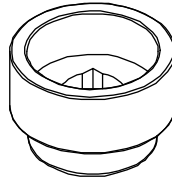

Spindle/ Spindle Extension Kit

Includes:

- 1 - 2 pc. Spindle
- 2 - Set screws

Length	PN
5 1/8"	10148458
5 3/32"	10148459

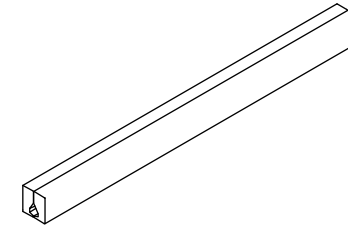

Spring Cartridge

PN
10830452



Lever Bushing, Contemporary

Color	PN
Gray	10148448
Natural	02062202
Black	10148020

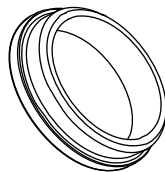

Gasket Post, Lug Seal

PN
10148404

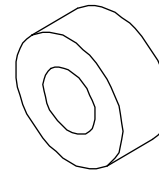

Gasket, Top Backplate

PN
10148405

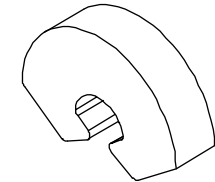

Keyed Cylinder, Lock

(Schlage "C" Keyway)

For service replacement only.

Includes:

2 - Keys

NOTE: For Keyed Alike orders, use program C87P2

Polished Chrome, White, Satin Nickel PVD, Matte Black use
Chrome Face

Satin Taupe, Antique Brass, Satin Chrome, Oil Rubbed
Bronze, Oil Rubbed Bronze PVD, Brass PVD, Dark Bronze
use Brass Face

Color	PN
Brass Face	10830212
Chrome Face	10830209

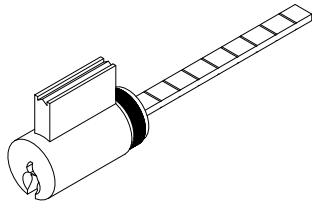

Panel Handle

NOTE: Fasteners are not included with the handle, order suggested fasteners from the chart below.

Color	PN
White	11102201
Satin Nickel	11102204
Dark Bronze	11102202
Matte Black	11102203

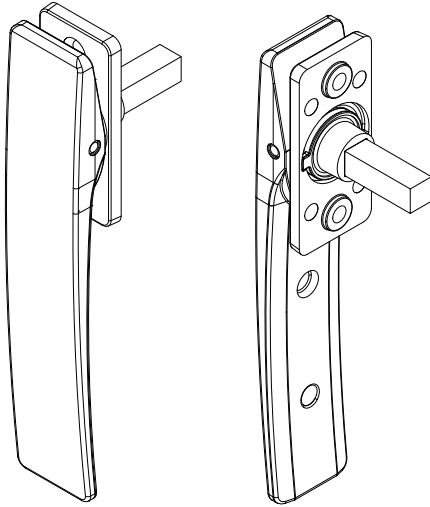

Suggested Fasteners		
2 - M5 x .8 x 17mm, Phillips, flat head, 1/2 thread machine screws		
Handle Color	Fastener Color	PN
White	White	11102212
Satin Nickel	Stainless Steel	11102211
Dark Bronze or Matte Black	Dark Bronze	11102210

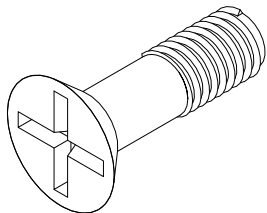

Pkg, Panel Strike Plate

Includes:

- 1 - Panel strike plate, Stainless Steel (05700049) and Oil Rubbed Bronze PVD (05700117)
- 2 - #8-18 x 1" Type AB, full thread, Phillips flat head screws, Stainless Steel (11800645) and Dark Bronze (11800652)

Color	PN
Stainless Steel	05700312
Oil Rubbed Bronze PVD	05700314

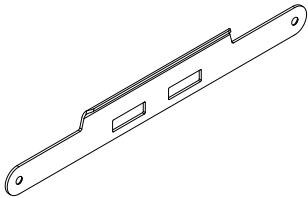

Shoot Bolt Guide

Includes:

- 1 - Shoot Bolt Guide
- 1 - #8 x 1 1/2" Phillips pan head wood screw

PN
10815199

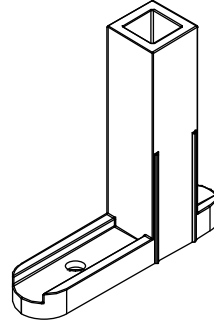

Sill Strike

Color	PN
Black	11869820
Beige	11869819

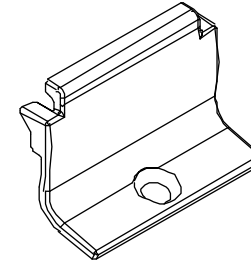

Panel Handle, Lock Box

Color	PN
Black	11102205

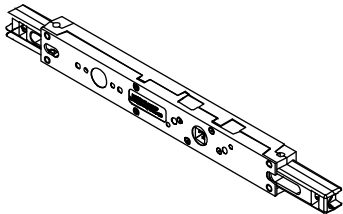

Cover Plate for Flush Bolt

Includes:

- 1 - Cover plate
- 2 - #8 x 1" screws

PN
11860402

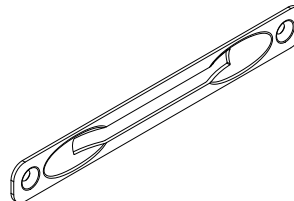

Head or Foot Flush Bolt, Inactive Panel

Color	PN
Black	11101780

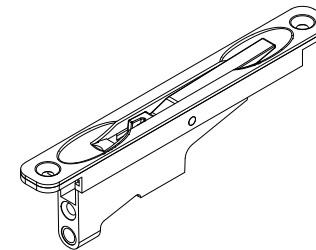

Mortise Lock, Active Single Point

Latch and dead bolt only

PN
05700129

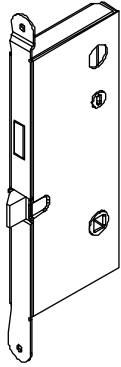

Mortise Lock, Active Multi-Point Lock

Latch, dead bolt and head/foot shoot bolts

PN
05700130

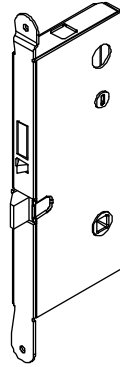

Mortise Lock, Inactive Panel Multi-Point Lock

Head/foot shoot bolts

PN
05700131

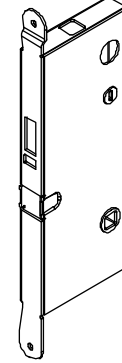

Strike Plate, Jamb/Panel Mortise Lock/Multi-Point Lock

Includes:

- 1 - Jamb strike plate
- 2 - #8-18 x 1" Type AB, Full thread, Phillips flat head screws, Stainless Steel (11800645) and Dark Bronze (11800652)

Color	PN
Stainless Steel	05700300
Oil Rubbed Bronze PVD	05700302

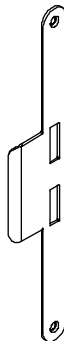

Cover Plate, Active Panel, Mortise Lock/Multi-Point Lock

Includes:

- 1 - Cover plate
- 2 - #8-18 x 1" Type AB, Full thread, Phillips flat head screws, Stainless Steel (11800645) and Dark Bronze (11800652)

Color	PN
Stainless Steel	05700306
Oil Rubbed Bronze PVD	05700308

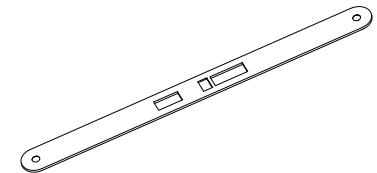

Shoot Bolt Assembly, Top for Multi-Point Lock

Solid stainless steel rod with 1/4" - 20 threads

NOTE: For special height give dimension A

CN Height	Top Locking Rod Length	Color	PN
6/8	35 3/4"	Stainless Steel	11102196
7/0	39 3/4"		11102197
8/0	49 1/4"		11102198
9/0	61 3/4"		11102199
10/0	73 1/4"		11102200

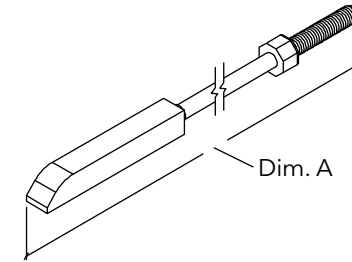

Locking Rod Assembly, Bottom for Multi-Point Lock

Solid stainless steel rod with 1/4" - 20 threads

CN Height	Btm Locking Rod Length	Color	PN
6/6R	34 9/32"	Stainless Steel	05700170
6/8			
7/0			
8/0			
9/0			

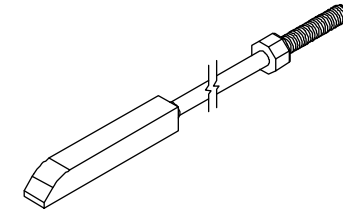

Inactive Panel Locking Rod Assembly, Top or Bottom Flush Bolt

Includes:

1 - Locking rod with end bolt

CN Height	Top Locking Rod Length	Color	PN
6/8	11"	Stainless Steel	05700180
7/0	11"		05700180
8/0	27"		05700185
9/0	34 1/4"		05700170
10/0	41 15/16"		05700177

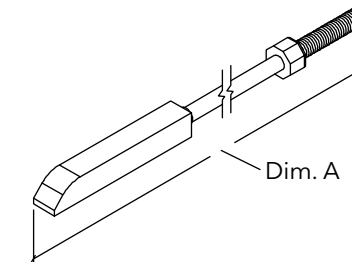

Height	Btm Locking Rod Length	Color	PN
All	11"	Stainless Steel	10815178

Tailpiece, Non-keyed, Button Switch

Color	PN
Stainless Steel	10501844

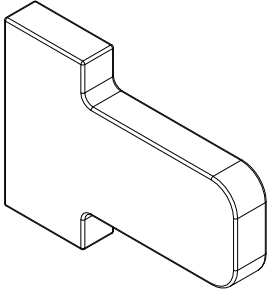

Cover, Transmitter

Color	PN
Brushed Stainless Steel	10501822

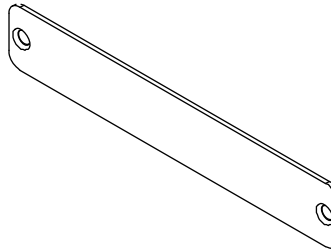

#8-18 x 1" Type AB, Full Thread

Used for Transmitter Cover
Need quantity of 2 for each part

PN
11800769

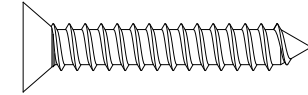

Micro Switch Assembly

Color	PN
Black	10501824

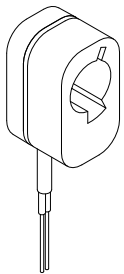

Lock Rod, Transmitter Recess, Shoot Bolt

Color	LH PN	RH PN
Brushed Stainless Steel	10501838	10501841

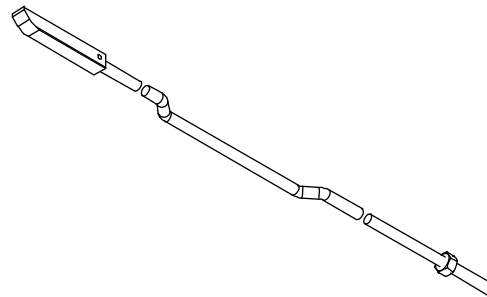

Straight Hinge Set, Interior

Color	PN
White	10840238
Satin Nickel	10840239
Bronze	10840237
Matte Black	10840236

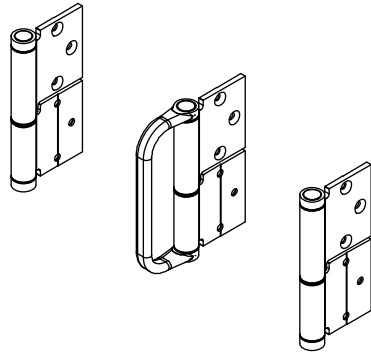

Offset Hinge Set, Interior

Color	PN
White	10840230
Satin Nickel	10840231
Bronze	10840229
Matte Black	10840228

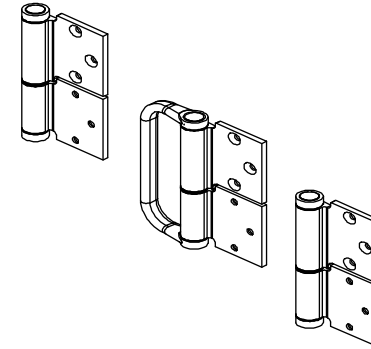

Center Hinge, Installation Template

NOTE: Not to Scale, must order by Part Number.
Includes Unit Installation Instructions.

PN
19972179

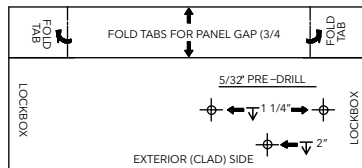

Intermediate Carrier, Top, Exterior

Color	PN
White	10840218
Satin Nickel	10840219
Bronze	10840217
Matte Black	10840216

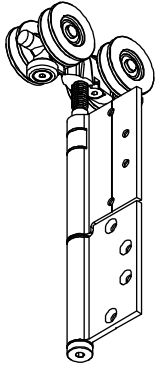

Intermediate Carrier, Bottom, Exterior

Color	PN
White	10840222
Satin Nickel	10840223
Bronze	10840221
Matte Black	10840220

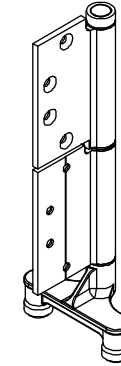

End Carrier, Top, Exterior

Color	Handing	PN
White	RH	10840242
	LH	10840246
Satin Nickel	RH	10840243
	LH	10840247
Bronze	RH	10840241
	LH	10840245
Matte Black	RH	10840240
	LH	10840244

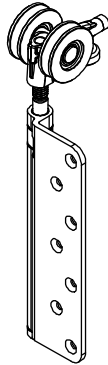

RH shown

End Carrier, Bottom, Exterior

Color	Handing	PN
White	RH	10840250
	LH	10840254
Satin Nickel	RH	10840251
	LH	10840255
Bronze	RH	10840249
	LH	10840253
Matte Black	RH	10840248
	LH	10840252

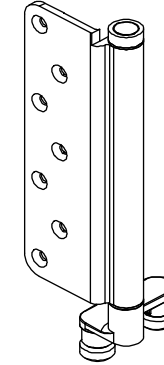

LH shown

Top Wall Pivot, Exterior

Color	Handing	PN
White	RH	10840202
	LH	10840206
Satin Nickel	RH	10840203
	LH	10840207
Bronze	RH	10840201
	LH	10840205
Matte Black	RH	10840200
	LH	10840204

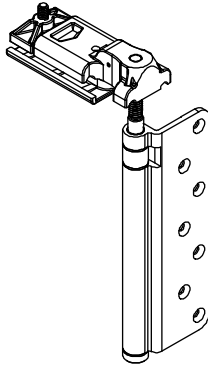

RH shown

Bottom Wall Pivot, Exterior

Color	Handing	PN
White	RH	10840210
	LH	10840214
Satin Nickel	RH	10840211
	LH	10840215
Bronze	RH	10840209
	LH	10840213
Matte Black	RH	10840208
	LH	10840212

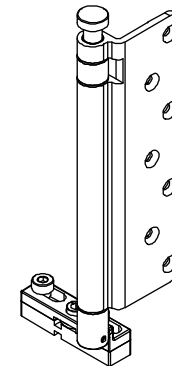

RH shown

Lower Pivot Shim

PN
10840256

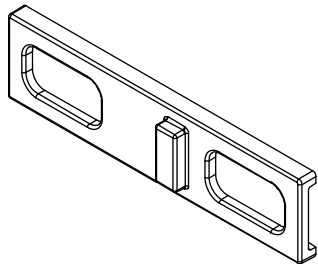

Panel Alignment Receiver

Color	PN
Beige	11869886
Black	11869887

Suggested Fasteners	
2 - #8 x 1 1/2" Phillips flat head screw	
Cashmere PN	Ebony PN
11805182 (Use with Beige)	11805140 (Use with Black)

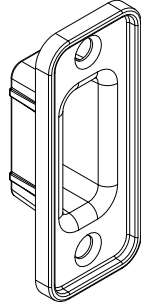

Panel Alignment Bolt

Color	PN
Beige	11102455
Black	11102456

Suggested Fasteners	
2 - #8 x 1 1/2" Phillips flat head screw	
Cashmere PN	Ebony PN
11805182 (Use with Beige)	11805140 (Use with Black)

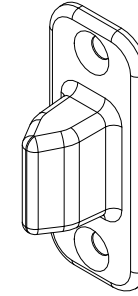

Pkg, Stile End Bracket

NOTE: Used on panels with a Panel Handle

Includes:

- 1 - Stile end bracket, top left/bottom right (A)
- 1 - Stile end bracket, top right/bottom left (B)
- 4 - #8-15 x 3" flat head, Stainless Steel screws

PN
11102233

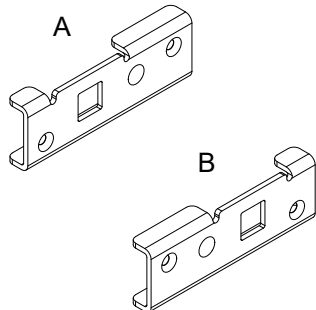

Panel Bumper Retainer

(Stationary Panel Bracket)

Color	PN
Bronze	11860081

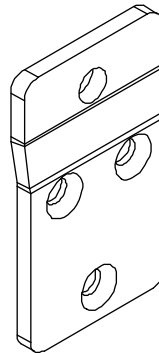

Cover Plate

PN
11102213

Suggested Fasteners
2 - #8-18 x 1" Type AB, full thread screw
PN
11800769

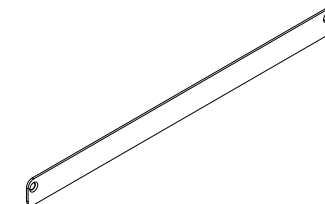

Magnetic Door Catch

Includes:

Assembly, cover and base

Color	PN
Stone White	11102457
Bronze	11102459
Ebony	11102458
Liberty Bronze	11102488
Pebble Gray	11102460
Gunmetal	11102461
Bahama Brown	11102482
Evergreen	11102483
Suede	11102484
Clay	11102485

Color	PN
Bright Silver	11102486
Copper	11102487
Sierra White	11102489
Coconut Cream	11102490
Cashmere	11102491
Cadet Gray	11102492
Hampton Sage	11102493
Cascade Blue	11102494
Wineberry	11102496

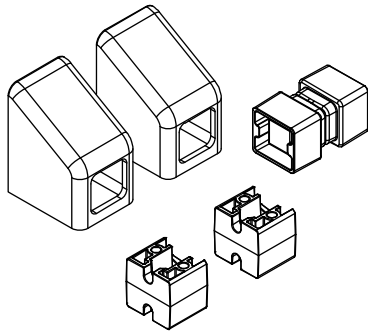

Magnetic Door Catch without Cover

Color	PN
Black	11102463

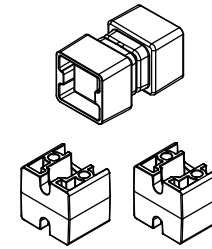

Ordering specifications (use all that apply):

1. Original order/line number (if available)
2. Profile number
3. Rough opening
4. Handing/Configuration
5. Location
6. Length
7. Finish

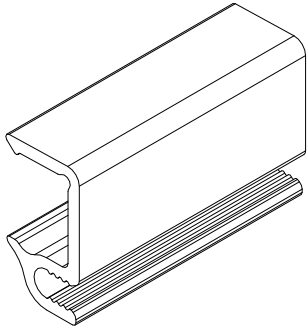

Rail Cap, A3052

NOTE: Specify top or bottom rail

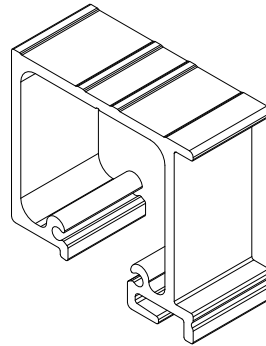

Head Track, A3113

NOTE: Used on Ultimate

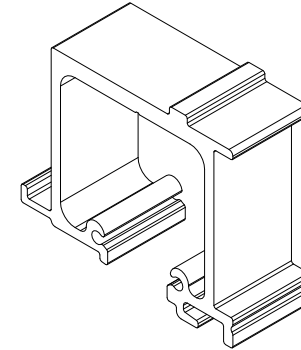

Head Track, A3229

NOTE: Used on Ultimate Wood

Frame Cover

V2690

Length	Color	PN
115 1/2"	Beige	15371799
	Black	15371899

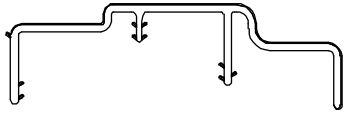

Shoot Bolt Channel

V2683

Length	Color	PN
179"	Beige	11211615
	Black	11211616

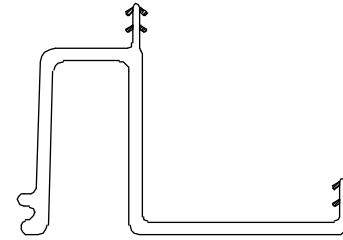

Glazing Bead

V2447

Length	Beige PN	Black
26 13/16" (681)	15371330	15371331
38 13/16" (986)	15371340	15371341
50 13/16" (1291)	15371350	15371351
73 1/2" (1867)	15371370	15371371
83" (2108)	15371380	15371381
95" (2413)	15371390	15371391
107" (2718)	15371310	15371311
131" (3327)	15371312	15371313

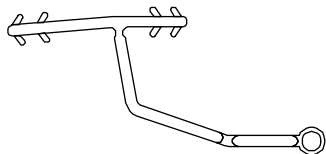

Ordering Specifications (use all that apply):

1. Original Order/Line number (if available)
2. Profile number
3. Rough opening
4. Handing
5. Length
6. Finish

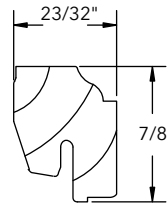

Ogee Glazing Cap, W12367

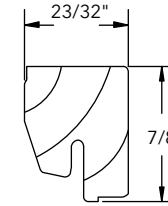

Square Glazing Cap, W12368

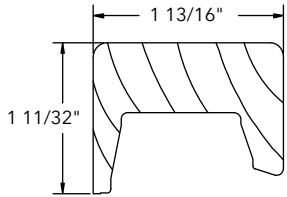

Square Astragal Cap, W12707

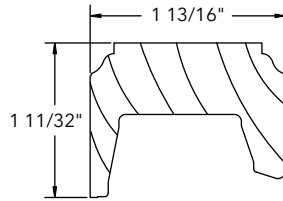

Ogee Astragal Cap, W12708

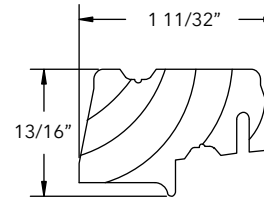

Astragal Base, W12709

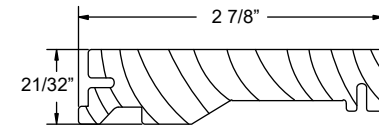

Head Jamb Part Stop, W12711

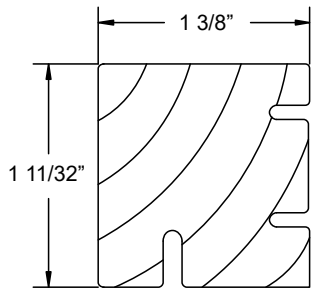

Jamb Part Stop, W12713

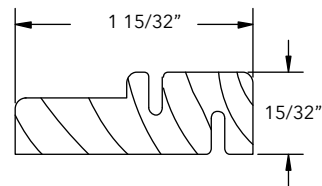

***Short Frame Cover Support, W12750**

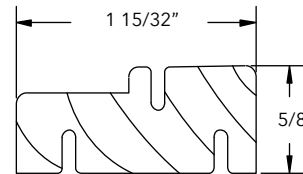

***Mid Frame Cover Support, W12752**

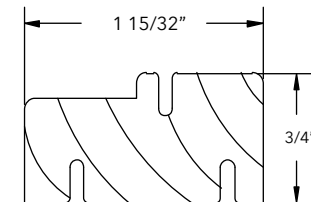

***Tall Frame Cover Support, W12751**

* See Installation Instruction PN 19915742 for usage.

Panel Weather Strip

V3020

Length	Color	PN
85"	Beige	11195405
	Black	11195420
	Bronze	11195435
97"	Black	11195425
120"	Beige	11195415
	Black	11195430

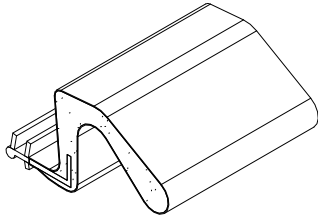

Offset Bulb Weather Strip, Mull Casing, Transom and Astragal

V796

Length	Color	PN
75 43/64"	Beige	15170866
	Black	15170867
104 7/8"	Beige	15170090
	Black	15170091
115 41/64"	Beige	15170810
	Black	15170811
189 23/32"	Beige	15173298
	Black	15173398

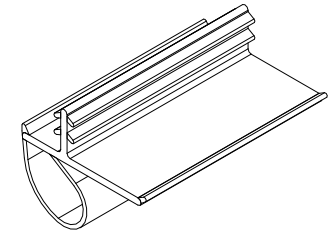

Panel Weather Strip

V1897

Length	Color	PN
Specify Length	Beige	11195201
	Black	11195202

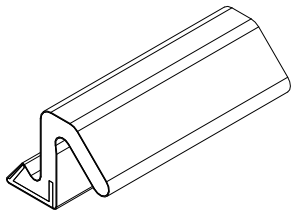

Top Rail Cap Weather Strip

V2475

Length	Color	PN
41 1/16"	Beige	11212336
	Black	11212337

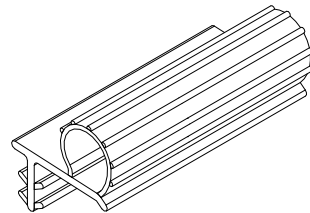

Hinge Weather Strip

V3021

NOTE: PN is sold by lineal FT. Each hinge requires approximately a 7.21" length.

Length	Color	PN
Specify Length	Beige	16220005
	Black	16220006

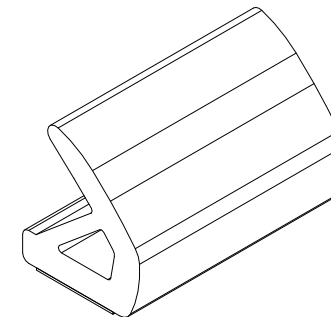

Weather Strip, Stile

V020

Length	Color	PN
150"	Beige	11197999
	Black	11197998

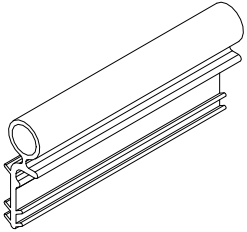

Weather Strip, Inactive

V1706

Length	Color	PN
121"	Beige	15618199
	Black	15618299

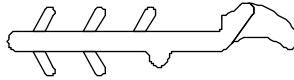

Weather Strip, Foam Leaf

V1194

Length	Color	PN
Specify Length	Beige	17003595
	Black	17003596

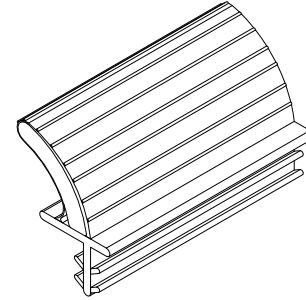

Jamb Part Stop Gasket (Pair)

Color	PN
Black	15600033

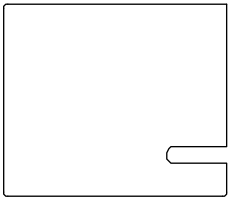

Panel Edge Gasket (Pair)

Color	PN
Beige	10500444
Black	10500446

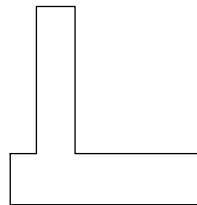

Jamb to Sill Weather Strip Gasket (Pair)

Color	PN
Black	15600034

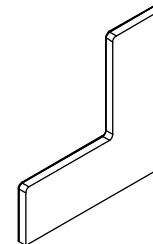

Ordering Specifications (use all that apply):

1. Profile number
2. Rough opening
3. Handing
4. Length
5. Color

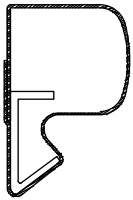

Panel Weather Strip, V2726

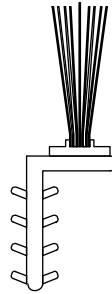

1/2" Pile Offset Weather Strip, V2791

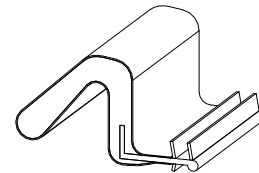

Frame Weather Strip, V3019

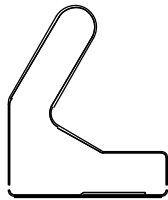

Hinge Weather Strip, V2725
No longer available, use current.

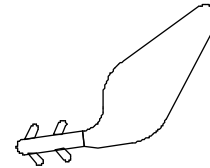

Weather Strip, V1138
No longer available, replace with V1194.

Ordering Specifications (use all that apply):

1. Original order number/line number
2. Panel OM (Note: Pane OM does not include astragals or weather strip)
3. Panel type—refer to panel and hinge configuration chart
4. Glazing type
5. Interior finish
6. Exterior color
7. Glazing bead profile: Ogee or Square

NOTE: Weather Strip and pile weather strip is included with panels. Active panels include multi-point lock system. Folding panels include panel cover and dust block.



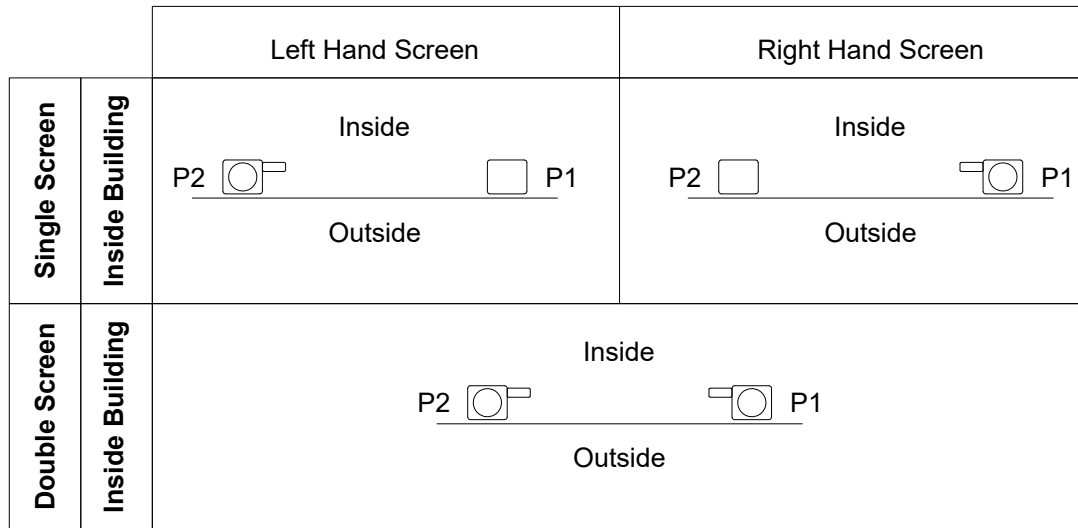

To order full unit sill covers and screen cartridges,
refer to configured parts in OMS.

Ordering specifications:

1. Original order number.

NOTE: Single screens: Marvin order number is found under the bottom stile cover on the opposite side of the tensioning springs. Double screens: Marvin order number is found under the bottom left hand stile cover on the opposite side of the tensioning springs (left hand when viewing from exterior).

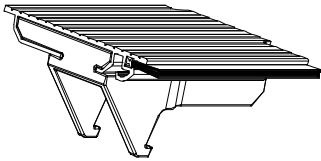

Sill Cover, Short End

Handing	Color	PN
LH	Clear Anodized	10504034
	Powder Bronze	10504044
	Powder White	10504046
	Powder Black	10504048
RH	Clear Anodized	10504035
	Powder Bronze	10504045
	Powder White	10504047
	Powder Black	10504049

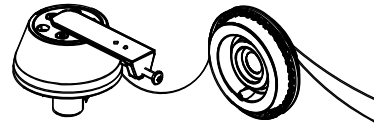

Cone Assembly

Handing	PN
LH	10504102
RH	10504103

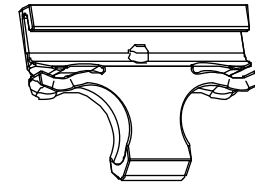

Screen Stop, Header, Bi-Parting

PN
10504106

Illustration not available

Cable

Color	PN
Black	10504098
Red	10504099
Yellow	10504100
Green	10504101

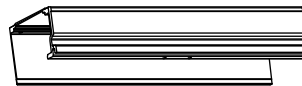

Splice Joiner

PN
10504139

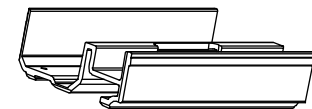

Splice Joiner, Sill

PN
10504175

Ordering specifications (use all that apply):

1. Original order number;
2. Total rough opening;
3. Part length;
4. Handing;
5. Finish (where applicable),

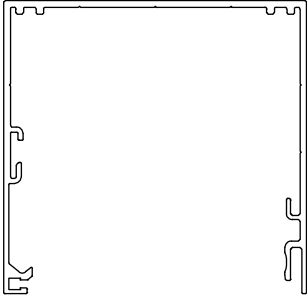

Head Jamb Frame
Head Jamb Frame, Spliced

Note: Spliced is available in LH or RH configurations

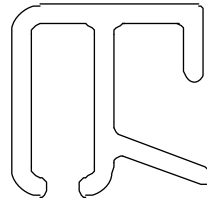

Tab Retainer, Head Jamb
Includes: Retainer clips



Cover, Head Jamb
Cover, Head Jamb, Spliced

Includes: Pile weather strip and retainer clips
Note: Spliced is available in LH or RH configurations.

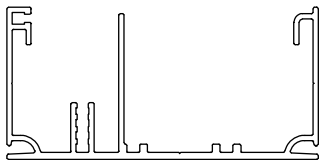

Sill, Frame
Sill, Spliced

Note: Spliced is available in LH or RH configurations

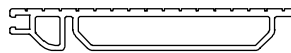

Sill Cover, Spliced
Includes: Pile weather strip and end caps
Note: Available in LH or RH configurations.

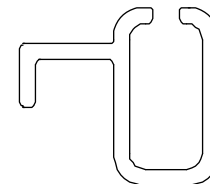

Tab Retainer, Sill
Tab Retainer, Sill, Spliced
Note: Spliced is available in LH or RH configurations.

Ordering specifications (use all that apply):

1. Original order number;
2. Total rough opening;
3. Part length;
4. Handing;
5. Finish (where applicable),

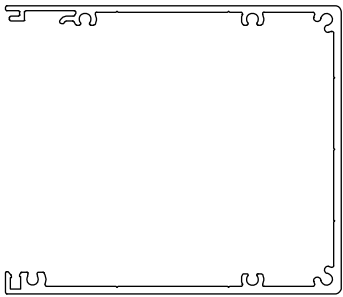

Frame, Jamb, No Cartridge
Jamb, Cartridge Side
Jamb, Bi-Parting

Note: Available in LH or RH configurations



Jamb Cover, Cartridge

Includes: Pile weather strip and retainer clips



Jamb Cover, Stationary

Includes: Magnets and retainer clips

Ordering specifications:

1. Original order number;

NOTE: Single screens: Marvin order number is found under the bottom stile cover on the opposite side of the tensioning springs. Double screens: Marvin order number is found under the bottom left hand stile cover on the opposite side of the tensioning springs (left hand when viewing screen from exterior).

Top Cartridge Bearing

Includes:

- 1 - Cable tensioner
- 1 - Top block slide pulley/bearing
- 4 - Screws

Usage dates:

Used prior to 04/27/2020

Handing	Color	PN
LH	Black	10501287
RH	Black	10501288



Top Handle Pull Assembly

Includes:

- 1 - Top stile cap
- 2 - Screws/cable crimp

Usage dates:

Used prior to 04/27/2020

Handing	Color	PN
LH	Black	10501291
RH	Black	10501292



Bottom Handle Pull Assembly

Includes:

- 1 - Bottom stile cap
- 2 - Screws/cable crimp

Usage dates:

Used prior to 04/27/2020

Handing	Color	PN
LH	Black	10501289
RH	Black	10501290



Ordering Specifications:

- 1. Original order number;

NOTE: Single screens: Marvin order number is found under the bottom stile cover on the opposite side of the tensioning springs. Double screens: Marvin order number is found under the bottom left hand stile cover on the opposite side of the tensioning springs (left hand when viewing screen from exterior).

Bi-Parting Screen Stop

Includes:

- 1 - Double screen stop

Usage dates:

Used prior to 04/27/2020

Color	PN
Black	10501296



Bottom Cartridge Bearing

Includes:

- 1 - Bottom bearing/pulley assembly
- 2 - Screws

Usage dates:

Used prior to 04/27/2020

Handing	PN
LH	10501299
RH	10501298



Spool Kit

Includes:

- 1 - LH/RH Cone
- 1 - Cable/crimp
- 1 - Cable connector
- 4 - Screws

NOTE: Part number is sold by LF

NOTE: Ultimate and Ultimate Wood Bi-Fold Door will use 13ft (cable) for each cone to connector.

Top Cables: width of screen plus half the height.

Bottom Cables: 2 times the width of the screen plus 1-1/12 times the height.

Usage dates:

Used prior to 04/27/2020

Length	Handing	Color	PN
Specify Length	LH	Black	10501294
	RH	Gray	10501293



Ordering Specifications:

- 1. Original order number;

NOTE: Single screens: Marvin order number is found under the bottom stile cover on the opposite side of the tensioning springs. Double screens: Marvin order number is found under the bottom left hand stile cover on the opposite side of the tensioning springs (left hand when viewing screen from exterior).

Cable

Usage dates:

Used prior to 04/27/2020

NOTE: Part number is sold by LF

NOTE: Ultimate and Ultimate Wood Bi-Fold Door will use 13ft (cable) for each cone to connector.

Top Cables: width of screen plus half the height.

Bottom Cables: 2 times the width of the screen plus 1-1/12 times the height.

Length	PN
Specify Length	10501259



Handle Pull Covers/Spring Kit

Includes:

- 4 - Stile covers
- 2 - Springs
- 4 - Spring keepers

Usage dates:

Used prior to 04/27/2020

PN
10501297



Ordering Specifications:

1. Original order number;
2. Total rough opening;
3. Part length;
4. Handing;
5. Finish (where applicable),

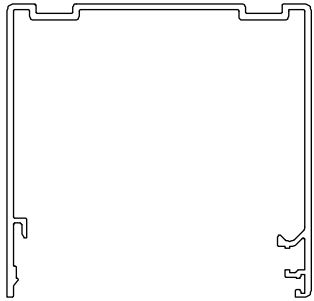

Head Jamb Frame

Includes: Weather strip
Used prior to 04/27/2020

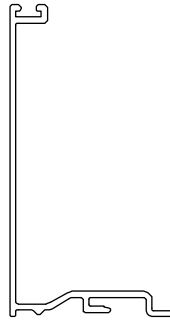

Head Jamb/Jamb Cover

Includes: Weather strip
Used prior to 04/27/2020

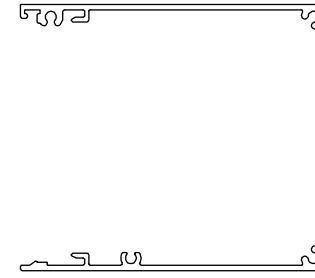

Jamb Frame

Includes weather strip
Used prior to 04/27/2020

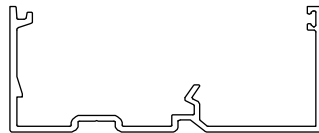

Sill

Includes: Weather strip
Used prior to 04/27/2020



Jamb Stop

Includes magnet strip
Used prior to 04/27/2020

The following parts are available as configured parts in OMS

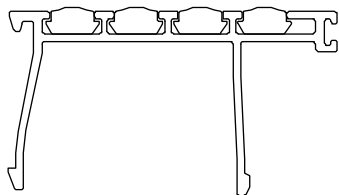

Sill Cover with Rubber Insert

Includes weather strip

Used prior to 04/27/2020

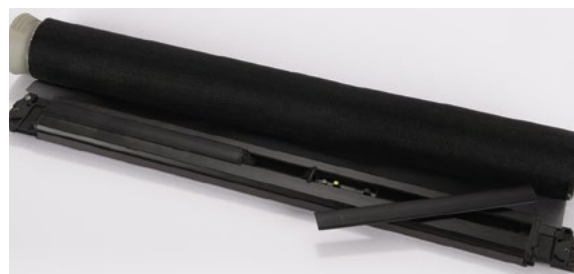

Cartridge

1 Complete cartridge assembly

Used prior to 04/27/2020