

# ULTIMATE DOUBLE HUNG INSERT G2 BMC PANNING INSTALLATION INSTRUCTIONS



**ATTENTION:** Please read entire instruction before attempting to install the BMC panning on your Ultimate Insert Double Hung G2.



## WARNING!



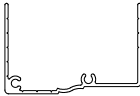
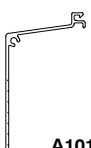
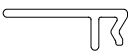
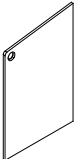
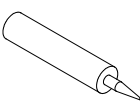

Drilling, sawing, sanding or machining wood products can expose you to wood dust, a substance known to the State of California to cause cancer. Avoid inhaling wood dust or use a dust mask or other safeguards for personal protection. For more information go to [www.P65Warnings.ca.gov/wood](http://www.P65Warnings.ca.gov/wood).

**CAUTION:** When using a power miter saw or hacksaw, always use the appropriate hand, eye, and ear protection to avoid injury. File all burrs or sharp edges from panning components after cutting them.

### PARTS INCLUDED WITH PANNING KITS

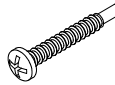
ILLUSTRATIONS (not to scale)	DESCRIPTION AND COLOR	PART/PROFILE NUMBER
 A1034	Jamb/Head jamb lineal casing 150" (3810)  Stone White (SW) Bronze (BZ) Pebble (PB) Brown (BN) Evergreen (EG)	  18575598 18575399 18575299 18575199 18575499
 A1016	Sill Panning 50" (1270) (available in 150" lineal lengths)  Stone White (SW) Bronze (BZ) Pebble (PB) Brown (BN) Evergreen (EG)	  18576598 18576399 18576299 18576199 18576499
 A1012	Frame Expander 150" (3810)  Stone White (SW) Bronze (BZ) Pebble (PB) Brown (BN) Evergreen (EG)	  18578599 18578399 18578299 18578199 18578499
	Sill End Cap <b>LH</b> Stone White (SW) Bronze (BZ) Pebble (PB) Brown (BN) Evergreen (EG) <b>RH</b> Stone White (SW) Bronze (BZ) Pebble (PB) Brown (BN) Evergreen (EG)	  18812060 18812040 18812030 18812020 18812050  18812061 18812041 18812031 18812021 18812051
	Color Matched Sealant  Stone White (SW) Bronze (BZ) Pebble (PB) Brown (BN) Evergreen (EG)	  11407102 11407053 11407052 11407051 11407054

### PARTS INCLUDED WITH PANNING KITS

ILLUSTRATIONS (not to scale)	DESCRIPTION AND COLOR	PART/PROFILE NUMBER
	6 - #8 x 3/4" Phillips stainless steel pan head screws  Stone White (SW) Bronze (BZ) Pebble (PB) Brown (BN) Evergreen (EG)	  02058050 11800838 11800837 11800836 11800839
	6 - #8 x 1 1/4" Phillips pan head screws	11800825
	24 - #8 x 1" Phillips flat head screws	11800740
	Frame kerf weather strip 13/64" diameter	15910100
 A1193	Sill Bottom Cover <i>NOTE: Optional part not included in panning kit.</i>  Stone White (SW) Bronze (BZ) Pebble (PB) Brown (BN) Evergreen (EG)	  18580599 18580399 18580299 18580199 18580499

*NOTE: Numbers listed in parentheses ( ) are metric equivalents in millimeters rounded to the nearest whole number.*

### YOU WILL NEED TO SUPPLY

- |  |                      |
|--|----------------------|
| Safety glasses   | Hearing protection   |
| Gloves   | Hammer               |
| Metal file   | Caulking gun         |
| Tape measure   | Screen spline roller |
| Hacksaw or appropriate shear   | 1/8" drill bit       |
| Hardwood block   |                      |
| Straight edge or speed square  |                      |
| Power drill/driver with Phillips head bit  |                      |
| Power miter saw with metal cutting blade   |                      |
| Table saw with metal cutting blade (or other tool to rip panning components to width)  |                      |
| Sealant - <i>Grade NS Class 25 per ASTM C920 (must be compatible with panning components and exterior surface of structure.)</i> |                      |

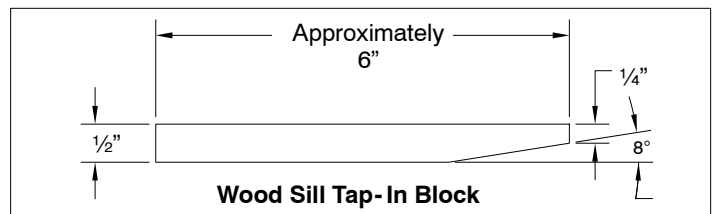

## Install Frame Kerf Weather Strip

- Using a screen spline roller or similar tool, apply frame kerf weather strip around the entire perimeter of insert frame as shown in figure 1. Do not overlap weather strip.

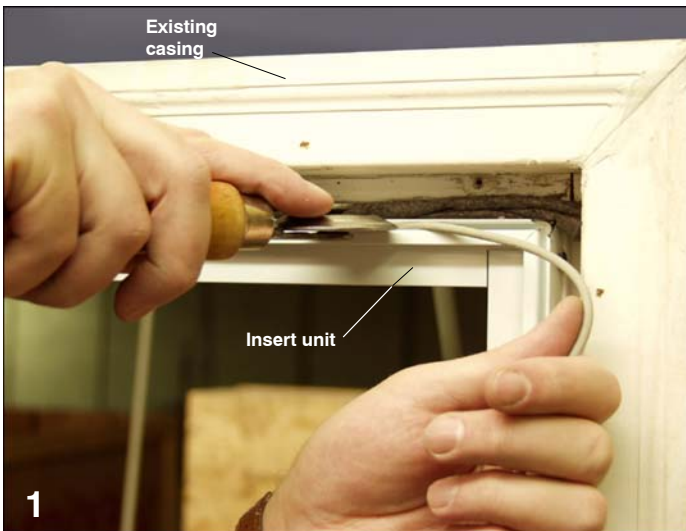

## Rip Panning Components

- When installed, the panning components must seat against the blind stop and interior side of existing casing. The exterior or "return" side of all panning components may need to be ripped to adjust for different exterior surfaces. See figure 2.

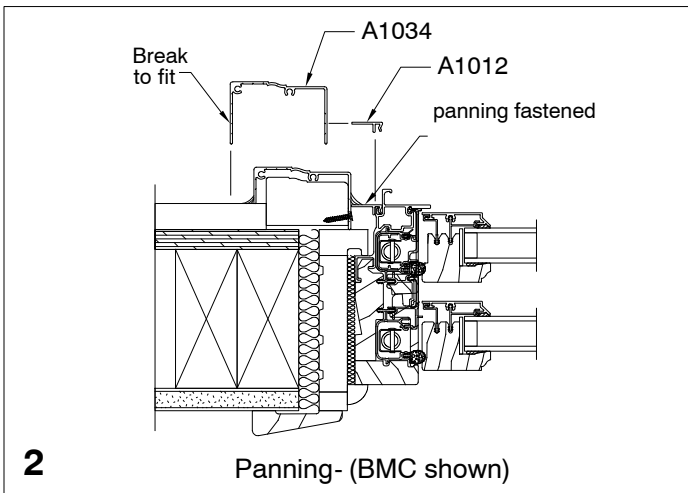

- Break lines are provided on the panning components and may be used as a guide for cutting on a table saw or brake. See figure 3.

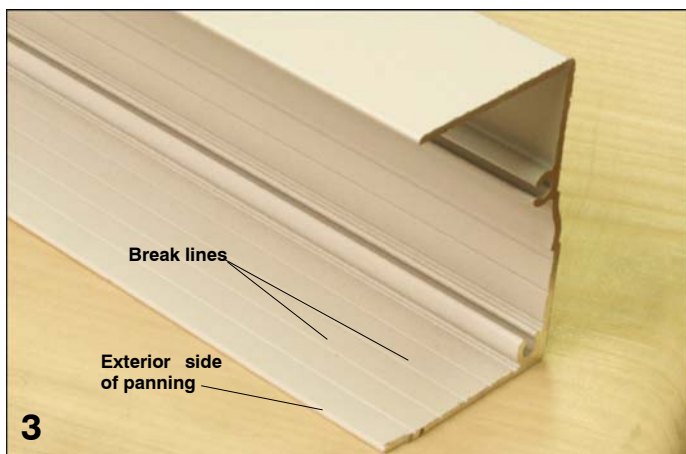

## Fabricate Sill Panning

- Measure the distance between the existing jamb casing. To this measurement add 4 9/16" (116). This will be the overall width of your sill panning as well as the width of the head jamb component and sill bottom cover. See figure 4.

**IMPORTANT:** If the face of the panning component was ripped, and thus the width of the component was reduced, use the following formula to determine the overall sill panning width.

$$[A \text{ \_\_\_ } + (2 \times B \text{ \_\_\_ }) = C \text{ \_\_\_ }]$$

Where:

**A** = Distance between existing jamb casing. See figure 4.

**B** = Flat casing width minus 1/16" (2)

**C** = Overall width of the sill panning component.



- Using a hacksaw or power miter saw, cut the sill panning component to the width calculated above or in the formula (see Important note above).
- Mark in from ends of sill component 2 5/16" (59). This is the width of the jamb panning minus 1/16" (2). If the face of the panning components was ripped, use the "B" calculation from the formula above.
- Using a straightedge or speed square and tape measure, calculate the depth of the insert unit from the furthest projection of the existing jamb casing. To this measurement add 1/16" and mark on sill panning. See figure 5.



- Extend these marks at right angles until they intersect. With a hacksaw, cut a notch in the sill panning and remove any burrs with a metal file. Remove an additional  $1/16$ " from the back side of the sill panning. This will allow clearance for the jamb panning. See figure 6. Test fit sill panning to make sure it fits properly around existing jamb casing. Some trimming may be necessary.

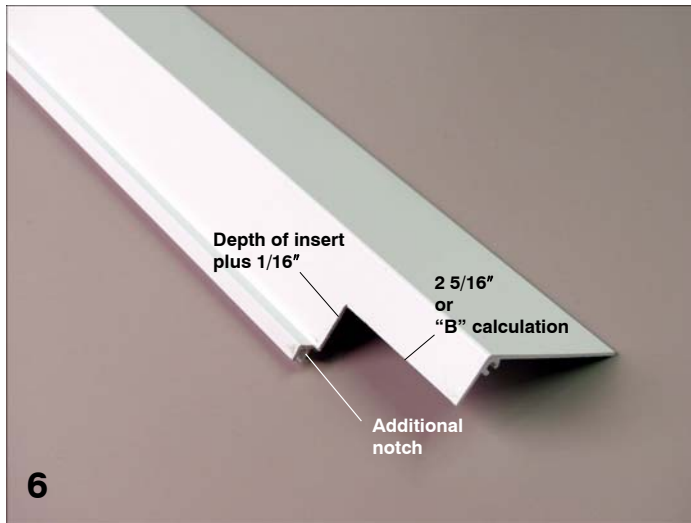

## Install Sill Panning

- Position the sill panning lip in accessory kerf of the frame. Using a hardwood block\*, start at one end of the sill panning and firmly tap on the wood block with a hammer, making two passes, to completely to seat the sill panning into the frame kerf. See figure 8.



\* See block specifications on page 1.

## Fabricate Jamb Pieces

- Using a power miter saw, cut ends of jamb pieces at eight (8) degrees to match sill panning bevel. Remove sharp edges and burrs with a metal file. See figure 9.

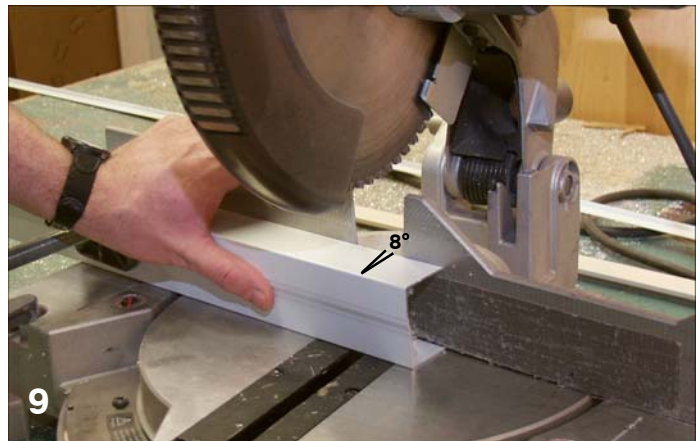

- Temporarily place a piece of the panning tightly against interior side of existing head jamb casing. Place one of the jamb panning components on frame making sure the bottom is tight against sill panning. Make a mark on jamb at bottom of head jamb panning as shown in figure 10. Cut a 45 degree angle with a power miter saw on this mark.



- Repeat steps 12 and 13 for opposite jamb.

## Optional Sill Bottom Cover Fabrication and Installation

*NOTE: If optional sill bottom cover (A1193) will not be used, proceed to next section, **Install Sill Panning.***

- Measure width of sill panning and cut sill bottom cover to same dimension with a hacksaw or power miter saw.
- The sill cover may need to be ripped to adjust for different exterior surfaces. This piece is used to keep the face of the sill panning in a vertical fashion. Break lines are provided on the cover and may be used as a guide for cutting using a table saw or brake.
- Place sill cover at desired height and center on sill. Secure the sill cover to the exterior with proper screws or other fasteners (type and size will vary depending upon exterior surface). See figure 7.



## Install Jamb Pieces

16. Set jamb pieces in place. Make sure jambs are tight against sill panning and interior edge of existing casing and blind stop. Drill pilot holes with a 1/8" drill bit every 8"-10" (203-254) making sure that holes are placed as close to the interior as possible (screws will be covered by frame expander installed in later steps). Fasten jamb panning to existing casing with #8 x 1" screws provided. See figure 11.



## Fabricate and Install Head Jamb Piece

17. With jamb pieces in place, measure from edge to edge to determine the width of the head jamb component. See figure 12. Cut head jamb piece at 45 degree angles with a power miter saw or hacksaw.



18. Using the dimensions detailed below, mark location of holes in head jamb piece, countersink and drill with a 1/8" drill bit. See figure 13. Attach head jamb to jamb with #8 x 3/4" screws.



19. Attach head jamb piece to existing casing by pre-drilling holes every 8"-10" and fastening with #8 x 1" screws as done before with the jambs.
20. End caps may need to be cut to allow for different exterior surfaces. Cut end caps with a hacksaw or appropriate shear on the longest side opposite of the pre-drilled screw hole. Drive the #8 x 3/4" screws through end cap into the sill screw boss using the pre-drilled screw holes. See figure 14.

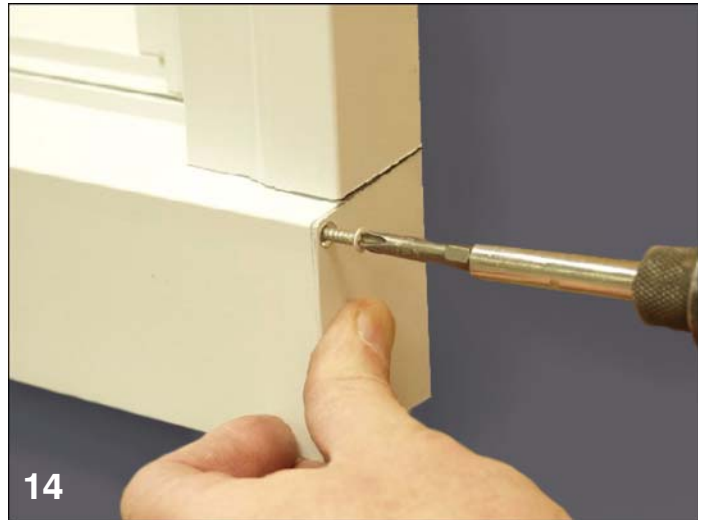

## Fabricate and Install Frame Expander

21. Place a bead of sealant where frame kerf weather strip meets. See figure 15.



22. If necessary, rip the frame expander to the needed width. (Frame expander will span the distance between the CINDH- NG 2.0 accessory kerf and the panning component. Distance may vary along head jamb and jamb. Adjust as necessary.)

23. Measure and cut head jamb piece first and install with a wood block and hammer. Repeat for jamb pieces. See figure 16.

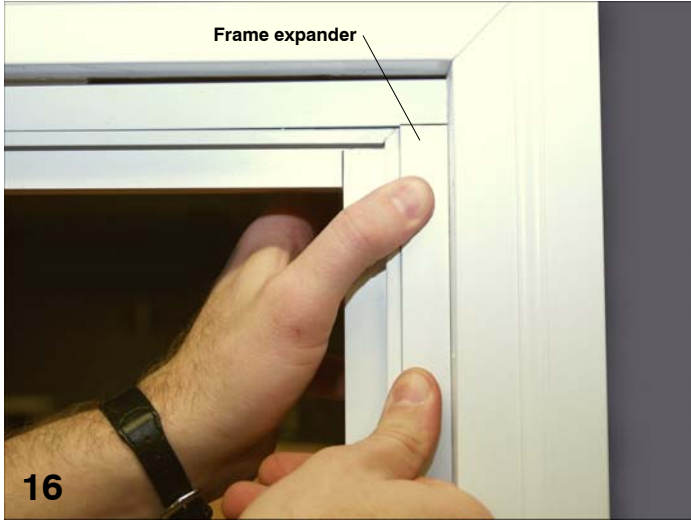

25. Be sure to tool out bead for best performance and aesthetics. See figure 19.



24. Seal all joints and exposed screw heads with color matched sealant. See figures 17 and 18.



26. Seal the joint between panning and exterior of dwelling with compatible sealant. Be sure to tool out bead of sealant for best performance.

