

# WOOD DIRECT GLAZE ROUND TOP – Double Hung

RT6 EYEBROW ABOVE SPRINGLINE STANDARD SIZES - DIRECT GLAZE

RO (mm)	2-2 3/8 (670)	2-6 3/8 (772)	2-8 3/8 (822)	2-10 3/8 (873)	3-0 3/8 (924)	3-2 3/8 (975)	3-6 3/8 (1076)
RO Rad. (mm)	2-0 1/2 (622)	2-0 1/2 (622)	2-6 1/2 (775)	2-6 1/2 (775)	2-6 1/2 (775)	3-4 1/2 (1029)	3-4 1/2 (1029)
	1-0 1/2 (318) 0-8 5/8 (219) UWDGRT2511	0-7 7/32 (183) UWDGRT2911	0-7 7/8 (200) UWDGRT3111	0-7 3/16 (183) UWDGRT3311	0-6 1/2 (165) UWDGRT3511	0-7 11/16 (195) UWDGRT3711	0-6 1/2 (165) UWDGRT4111
	1-6 1/2 (470) 1-2 5/8 (372) UWDGRT2519	1-1 7/32 (336) UWDGRT2919	1-1 7/8 (352) UWDGRT3119	1-1 3/16 (335) UWDGRT3319	1-0 1/2 (318) UWDGRT3519	1-1 11/16 (348) UWDGRT3719	1-0 1/2 (318) UWDGRT4119
	2-0 1/2 (622) 1-8 5/8 (624) UWDGRT2523	1-7 7/32 (488) UWDGRT2923	1-7 7/8 (505) UWDGRT3123	1-7 3/16 (487) UWDGRT3323	1-6 1/2 (470) UWDGRT3523	1-7 11/16 (500) UWDGRT3723	1-6 1/2 (470) UWDGRT4123
	3-0 1/2 (927) 2-8 5/8 (829) UWDGRT2535	2-7 7/32 (793) UWDGRT2935	2-7 7/8 (810) UWDGRT3135	2-7 3/16 (792) UWDGRT3335	2-6 1/2 (775) UWDGRT3535	2-7 11/16 (805) UWDGRT3735	2-6 1/2 (775) UWDGRT4135
	4-0 1/2 (1232) 3-8 5/8 (1133) UWDGRT2547	3-7 7/32 (1098) UWDGRT2947	3-7 7/8 (1114) UWDGRT3147	3-7 3/16 (1097) UWDGRT3347	3-6 1/2 (1080) UWDGRT3547	3-7 11/16 (1110) UWDGRT3747	3-6 1/2 (1080) UWDGRT4147
	5-0 1/2 (1537) 4-8 5/8 (1438) UWDGRT2559	4-7 7/32 (1403) UWDGRT2959	4-7 7/8 (1419) UWDGRT3159	4-7 3/16 (1402) UWDGRT3359	4-6 1/2 (1384) UWDGRT3559	4-7 11/16 (1414) UWDGRT3759	4-6 1/2 (1384) UWDGRT4159
	6-0 1/2 (1842) 5-8 5/8 (1743) UWDGRT2571	5-7 7/32 (1707) UWDGRT2971	5-7 7/8 (1724) UWDGRT3171	5-7 3/16 (1707) UWDGRT3371	5-6 1/2 (1689) UWDGRT3571	5-7 11/16 (1719) UWDGRT3771	5-6 1/2 (1689) UWDGRT4171
<b>RO (mm)</b>		<b>RO Splh. (mm)</b>	<b>RO Splh. (mm)</b>	<b>RO Splh. (mm)</b>	<b>RO Splh. (mm)</b>	<b>RO Splh. (mm)</b>	<b>RO Splh. (mm)</b>

Details and Elevations not to scale.

- If these units are NOT used as transoms, ADD 1 3/32" (28) to the rough opening height for subsill.































Please consult your local Marvin representative for more information.

For further details and drawings visit the "Tools and Documents" section at Marvin.com.

Ultimate Wood Direct Glaze Round Top: UWDGRT

# WOOD DIRECT GLAZE ROUND TOP – Double Hung

RT6 EYEBROW ABOVE SPRINGLINE STANDARD SIZES - DIRECT GLAZE

RO (mm)	3-10 3/8 (1178)	4-3 3/4 (1314)	4-11 3/4 (1518)	5-7 3/4 (1721)	6-3 3/4 (1924)
RO Rad. (mm)	3-4 1/2 (1029)	3-4 1/2 (1029)	4-6 1/2 (1384)	6-0 1/2 (1842)	6-0 1/2 (1842)
<b>RO (mm)</b>	1-6 1/2 (470)	0-9 5/32 (233)	0-9 9/16 (243)	0-10 1/8 (257)	0-7 13/16 (198)
<b>RO Splin. (mm)</b>	1-6 1/2 (470) 0-11 7/32 (285)	0-9 5/32 (233)	0-9 9/16 (243)	0-10 1/8 (257)	0-7 13/16 (198)
	 UWDGRT4519	 UWDGRT5119	 UWDGRT5919	 UWDGRT6719	 UWDGRT7519
	 UWDGRT4523	 UWDGRT5123	 UWDGRT5923	 UWDGRT6723	 UWDGRT7523
	 UWDGRT4535	 UWDGRT5135	 UWDGRT5935	 UWDGRT6735	 UWDGRT7535
	 UWDGRT4547	 UWDGRT5147	 UWDGRT5947	 UWDGRT6747	 UWDGRT7547
	 UWDGRT4559	 UWDGRT5159	 UWDGRT5959	 UWDGRT6759	 UWDGRT7559
	 UWDGRT4571	 UWDGRT5171	 UWDGRT5971	 UWDGRT6771	 UWDGRT7571
<b>RO (mm)</b>	2-0 1/2 (622)	1-3 5/32 (385)	1-3 9/16 (395)	1-4 1/8 (410)	1-1 13/16 (351)
<b>RO Splin. (mm)</b>	2-0 1/2 (622) 1-5 7/32 (437)	1-3 5/32 (385)	1-3 9/16 (395)	1-4 1/8 (410)	1-1 13/16 (351)
	3-0 1/2 (927)	2-3 5/32 (690)	2-3 9/16 (700)	2-4 1/8 (714)	2-1 13/16 (656)
<b>RO (mm)</b>	3-0 1/2 (927)	2-3 5/32 (690)	2-3 9/16 (700)	2-4 1/8 (714)	2-1 13/16 (656)
<b>RO Splin. (mm)</b>	3-0 1/2 (927) 2-5 7/32 (742)	2-3 5/32 (690)	2-3 9/16 (700)	2-4 1/8 (714)	2-1 13/16 (656)
	4-0 1/2 (1232)	3-3 5/32 (895)	3-3 9/16 (1005)	3-4 1/8 (1019)	3-1 13/16 (960)
<b>RO (mm)</b>	4-0 1/2 (1232)	3-3 5/32 (895)	3-3 9/16 (1005)	3-4 1/8 (1019)	3-1 13/16 (960)
<b>RO Splin. (mm)</b>	4-0 1/2 (1232) 3-5 7/32 (1047)	3-3 5/32 (895)	3-3 9/16 (1005)	3-4 1/8 (1019)	3-1 13/16 (960)
	5-0 1/2 (1537)	4-3 5/32 (1299)	4-3 9/16 (1310)	4-4 1/8 (1324)	4-1 13/16 (1265)
<b>RO (mm)</b>	5-0 1/2 (1537)	4-3 5/32 (1299)	4-3 9/16 (1310)	4-4 1/8 (1324)	4-1 13/16 (1265)
<b>RO Splin. (mm)</b>	5-0 1/2 (1537) 4-5 7/32 (1352)	4-3 5/32 (1299)	4-3 9/16 (1310)	4-4 1/8 (1324)	4-1 13/16 (1265)
	6-0 1/2 (1842)	5-3 5/32 (1604)	5-3 9/16 (1614)	5-4 1/8 (1629)	5-1 13/16 (1570)
<b>RO (mm)</b>	6-0 1/2 (1842)	5-3 5/32 (1604)	5-3 9/16 (1614)	5-4 1/8 (1629)	5-1 13/16 (1570)
<b>RO Splin. (mm)</b>	6-0 1/2 (1842) 5-5 7/32 (1657)	5-3 5/32 (1604)	5-3 9/16 (1614)	5-4 1/8 (1629)	5-1 13/16 (1570)

# WOOD DIRECT GLAZE ROUND TOP – Double Hung

## RT1 TRUE HALF CIRCLE STANDARD SIZES - DIRECT GLAZE

RO (mm)	2-6 3/8 (772)	2-8 3/8 (822)	2-10 3/8 (873)	3-0 3/8 (924)	3-2 3/8 (975)	3-6 3/8 (1076)
	1-3 3/16 (386)	1-4 3/16 (411)	1-5 3/16 (437)	1-6 3/16 (462)	1-7 3/16 (487)	1-9 3/16 (538)
	UWDGRT2914	UWDGRT3115	UWDGRT3316	UWDGRT3517	UWDGRT3718	UWDGRT4120
RO (mm)						
RO (mm)	3-10 3/8 (1178)	4-3 3/4 (1314)	4-11 3/4 (1518)	5-7 3/4 (1721)		6-3 3/4 (1924)
	1-11 3/16 (589)	2-1 7/8 (657)	2-5 7/8 (759)	2-9 7/8 (860)		3-1 7/8 (962)
	UWDGRT4522	UWDGRT5025	UWDGRT5828	UWDGRT6632		UWDGRT7437
RO (mm)						

## RT29 ELLIPTICAL STANDARD SIZES - DIRECT GLAZE

RO (mm)	4-3 3/4 (1314)	4-11 3/4 (1518)	5-7 3/4 (1721)	6-3 3/4 (1924)
	1-5 5/16 (456)			
	UWDGRT5118	UWDGRT5918	UWDGRT6718	UWDGRT7518
RO (mm)				

## CONSTRUCTION DETAILS

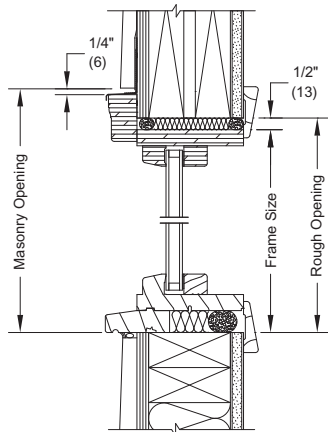

HEAD JAMB AND SILL - DIRECT GLAZE

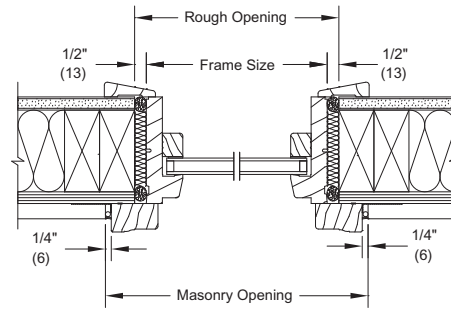

JAMB - DIRECT GLAZE

Details and Elevations not to scale.

- If these units are NOT used as transoms, ADD 1 3/32" (28) to the rough opening height for subsill.

Please consult your local Marvin representative for more information.

For further details and drawings visit the 'Tools and Documents' section at Marvin.com.