



Ultimate Wood Outswing French Door 2 1/4inch Arch Top

Replacement Parts

Specifications and technical data are subject to change without notice.

Numbers listed in () parentheses are metric equivalents in millimeters rounded to the nearest whole number.

Suggested fasteners are not included and must be ordered separately.

Illustrations are not to scale.

Contents

Product History.....	2
Part Identification - Operator XX R.....	3
Installation Parts.....	4
Traditional Handle.....	5
Contemporary Handle	10
Handle - Keyed Cylinder.....	15
Handle Set - Discontinued Limited Availability (LA).....	16
Hinge Handing Location	18
Hinges.....	19
Locking Hardware	21
Miscellaneous Parts	26
Miscellaneous Parts - Discontinued Limited Availability (LA)	27
Miscellaneous Parts - Discontinued No Availability (NA).....	28
Aluminum Parts - Discontinued Limited Availability (LA)	29
Fiberglass Parts.....	30
Vinyl Parts.....	31
Wood Parts.....	32
Wood Parts - Discontinued Limited Availability (LA)	34
Weather Strip	35
Weather Strip - Discontinued Limited Availability (LA).....	38
Panel Replacement	39

Produced	Unit Type	Features and Changes
2005	Ultimate Wood Outswing French Door 2 1/4inch Arch Top	5/31/2005: 2 1/4inch Panel IZ3 doors introduced. Units feature multi-point lock, LVL stiles and rails, and 4 1/2" x 4 1/2" ball bearing hinges.
2006	Ultimate Wood Outswing French Door 2 1/4inch Arch Top	11/20/2006: Introduced the 2 1/4inch door as a standard residential product.
2007	Ultimate Wood Outswing French Door 2 1/4inch Arch Top	2/20/2007: Introduced raised and flat panels as a standard option.
2008	Ultimate Wood Outswing French Door 2 1/4inch Arch Top	7/28/2008: Mixed grain Douglas fir is now a standard option.
2009	Ultimate Wood Outswing French Door 2 1/4inch Arch Top	3/23/2009: Added LoE-366 as a standard option for all products. Added Cedro Macho as a standard option for all Ultimate products. 3/30/2009: Implemented design changes to the 2 1/4inch Outswing. Changes include new panel sweep, dust blocks, IZ3/IZ4 wood bead and shoot bolt reinforcement.
2010	Ultimate Wood Outswing French Door 2 1/4inch Arch Top	2/22/2010: Added Dark Bronze hardware finish to doors.
2011	Ultimate Wood Outswing French Door 2 1/4inch Arch Top	4/25/2011: Added LoE-180 as a standard option for all products. White painted interior finish option introduced for all products.
2012	Ultimate Wood Outswing French Door 2 1/4inch Arch Top	7/30/2012: Adjustable Hinge became standard. 10/29/2012: Interior Square Sticking/Glazing Bead option introduced. 12/17/2012: Introduced Clear Interior Finish option on all products.
2013	Ultimate Wood Outswing French Door 2 1/4inch Arch Top	4/29/2013: Introduced interior stain options. Stain colors are Wheat, Honey, Leather, Hazelnut, Cabernet and Espresso. 12/16/2013: Interior Shades option introduced.
2014	Ultimate Wood Outswing French Door 2 1/4inch Arch Top	2/24/2014: Introduced two Pearlescent colors (Bright Silver and Copper) and discontinued colors (Sherwood Green and Cobalt Blue) to the Ultimate Doors. Removed screen information and added new chapter for screen to manual. 4/28/2014: Added the Contemporary Panel and Contemporary Handle options. 6/23/2014: Added PVD color options for the Contemporary Handle; Oil Rubbed Bronze PVD and Satin Nickel PVD are now available. 8/25/2014: Panel drip and screws (A2408) will now match standard color. Screws for custom color will be stainless steel.
2015	Ultimate Wood Outswing French Door 2 1/4inch Arch Top	6/06/2015 Replace the current sweep profiles for the Outswing doors. V1713 and V1657 are replaced with V2416 and V2427. The A2408 Panel Drip is no longer needed with this new sweep design.
2016	Ultimate Wood Outswing French Door 2 1/4inch Arch Top	10/31/2016: Discontinued the wood species Cedro Macho for all products.
2023	Ultimate Wood Outswing French Door 2 1/4inch Arch Top	2/27/2023: IZ3 certified Ultimate Wood 2 1/4" doors were moved to Discontinued - Limited Availability (DISC LA). This move allows for continued replacement and configured part support but does not allow ordering full IZ3 Wood Ultimate 2 1/4" door units. See Product Bulletin 861 for more information. 10/30/2023: An ERS coating became available as a standard option for current Triple Pane offerings. See Product Bulletin 904 for more details.

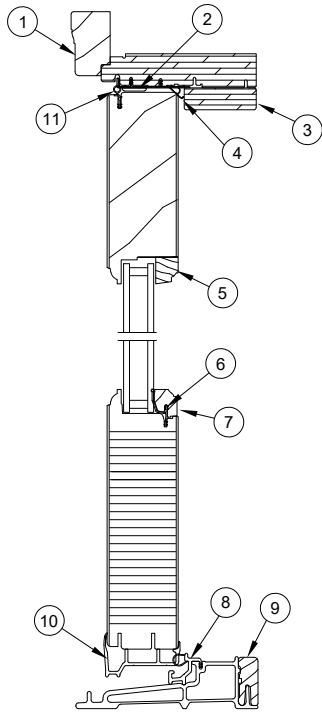

Head Jamb
and Sill

1. Head Jamb Brick Mould Casing
2. Frame Weather Strip, V1732
3. Head Jamb/Jamb Stop, W9951
4. Bulb Weather Strip, V1733
5. Radiused Glazing Bead, W12841
6. Glazing Bead, W9949
7. Vinyl Glazing Bead, V2447
8. Sill Weather Strip, V1659
9. Sill Liner, W2528
10. Sweep, V2416
11. Stile Weather Strip, V020
12. Interior Handle
13. Astragal Weather Strip, V796
14. Astragal, W8775
15. Astragal Base. W1455
16. Connecting Barb, V803
17. Inactive Panel Weather Strip, V1706
18. Exterior Handle
19. Adjustable Hinge

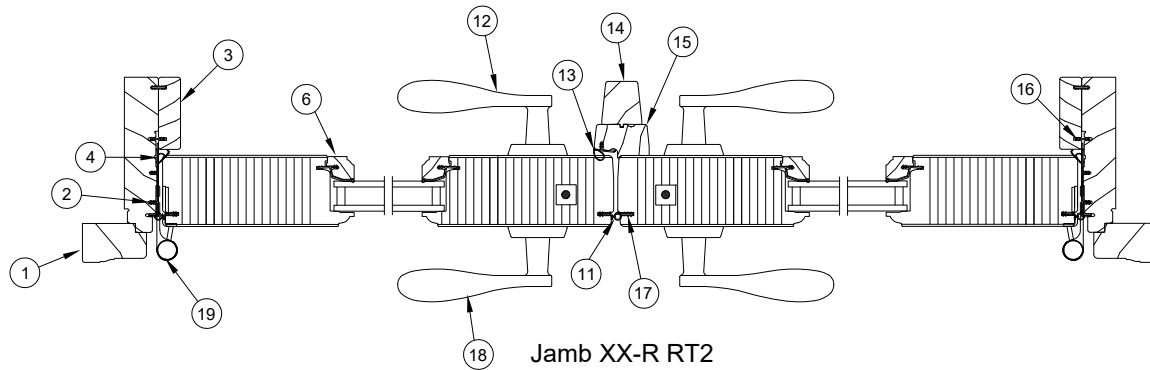

Jamb XX-R RT2

Construction Handle

PN

10830451

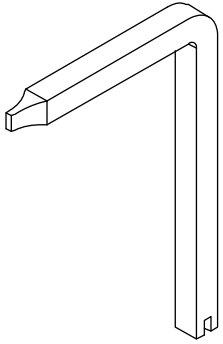

Handle Assembly, Active, Keyed

Mortise Lock and Multi-Point Lock Systems (Schlage "C" Keyway)

Includes:

- 1 - Interior lever with spindle, escutcheon plate and hardware
- 1 - Exterior lever with escutcheon plate and hardware
- 1 - Thumb turn with hardware (A)
- 1 - Keyed cylinder with housing and hardware, includes 2 keys (B)
- 1 - Exterior escutcheon plate gasket
- 2 - Lug Seal (C)
- 1 - Two piece spindle, 5.06" w/2 1/4" panel (D)
- 2 - #10-32 x 2 5/8" Phillips oval head machine screws (w/2 1/4" Panel) (E)

Handle Assembly - 2 1/4" Panel	
Color	PN
Satin Taupe	21448114
Antique Brass	21448116
White	21448119
Satin Chrome	21448112
Oil Rubbed Bronze	21448111
Oil Rubbed Bronze PVD	21448118
Brass PVD	21448160
Satin Nickel PVD	21448110
Dark Bronze	21448120
Polished Chrome	21448117
Matte Black	21448131

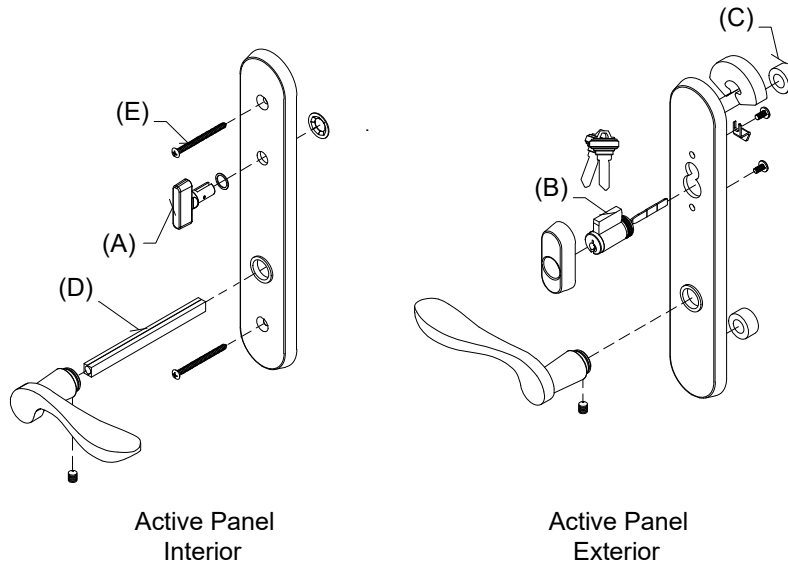

Handle Assembly, Active, Non-Keyed

Mortise Lock and Multi-Point Lock Systems (Schlage "C" Keyway)

Includes:

- 2 - Levers
- 2 - Lever bushings (D)
- 2 - Lug seals (C)
- 1 - Interior escutcheon
- 1 - Exterior escutcheon
- 1 - Thumb turn with actuator/tail piece (B)
- 1 - Two piece spindle, 5.06" w/2 1/4" panel (A)
- 2 - #10-32 x 2 5/8" Phillips oval head machine screws (w/2 1/4" Panel) (E)
- 2 - Set screws
- 1 - Allen wrench
- 1 - Installation instruction

Handle Assembly - 2 1/4" Panel	
Color	PN
Satin Taupe	21448174
Antique Brass	21448180
White	21448176
Satin Chrome	21448173
Oil Rubbed Bronze	21448172
Oil Rubbed Bronze PVD	21448170
Brass PVD	21448177
Satin Nickel PVD	21448181
Dark Bronze	21448178
Polished Chrome	21448175
Matte Black	21448179

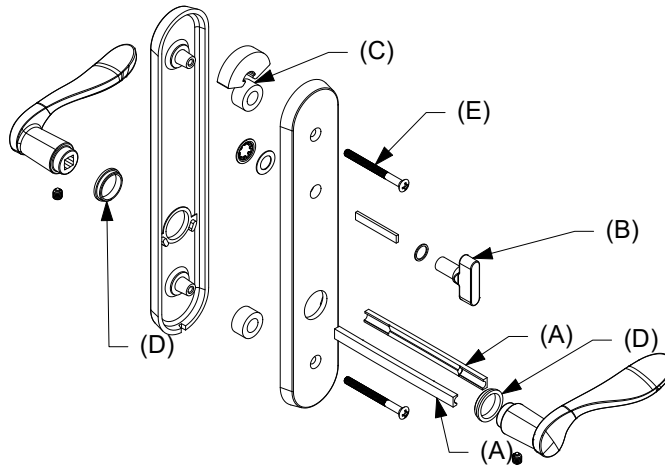

Handle Assembly, Inactive/Dummy

Includes:

- 1 - Interior lever with spindle, escutcheon plate and hardware
- 1 - Exterior lever with escutcheon plate and hardware
- 1 - Exterior escutcheon plate gasket
- 1 - Exterior escutcheon plate
- 2 - Lug seals (A)
- 1 - Two piece spindle, 5.06" (w/2 1/4" panel) (B)
- 2 - #10-32 x 2 5/8" Phillips oval head machine screws (w/2 1/4" Panel) (C)

Handle Assembly - 2 1/4" Panel	
Color	PN
Satin Taupe	21448151
Antique Brass	21448147
White	21448150
Satin Chrome	21448153
Oil Rubbed Bronze	21448154
Oil Rubbed Bronze PVD	21448145
Brass PVD	21448161
Satin Nickel PVD	21448133
Dark Bronze	21448162
Polished Chrome	21448148
Matte Black	21448163

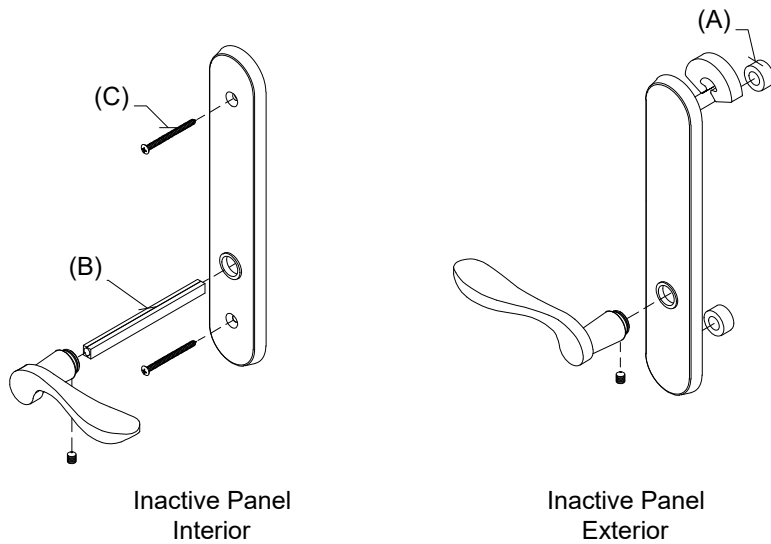

Inactive Panel
Interior

Inactive Panel
Exterior

Thumb Turn, Traditional

For Keyed Handle

Includes:

- Thumb Turn Washer
- Thumb Turn Push Nut

No Tail Piece/Actuator (for keyed handle)	
Color	PN
Antique Brass	10148483
Satin Chrome	10148482
Oil Rubbed Bronze	10148481
Oil Rubbed Bronze PVD	10148485
Polished Chrome	10148488
Brass PVD	10148484
Satin Nickel PVD	10148487
Satin Taupe	10148486
Dark Bronze	10148479
White	10148489
Matte Black	10148480

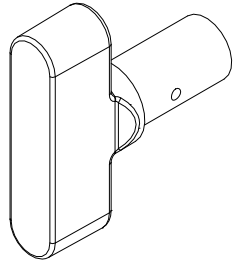

Thumb Turn, Traditional with Actuator/Tail Piece

For Non-Keyed Handle

Includes:

- Actuator/Tailpiece
- Thumb Turn Washer
- Thumb Turn Push Nut

With Tail Piece/Actuator (for non-keyed handle)	
Color	PN
Antique Brass	10148495
Satin Chrome	10148494
Oil Rubbed Bronze	10148493
Oil Rubbed Bronze PVD	10148497
Polished Chrome	10148500
Brass PVD	10148496
Satin Nickel PVD	10148499
Satin Taupe	10148498
Dark Bronze	10148491
White	10148501
Matte Black	10148492

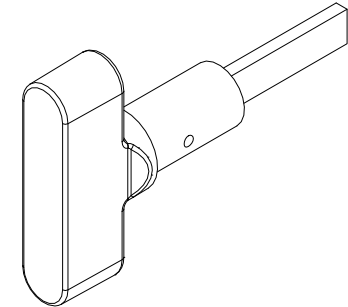

#10-32 x 2 5/8" Phillips Oval Head Machine Screw

For 2 1/4" Panels

Color	PN
Satin Taupe	11800237
Antique Brass	11800234
Satin Chrome	11800233
Polished Chrome	11800239
White	11800240
Oil Rubbed Bronze	11800232
Oil Rubbed Bronze PVD	11800236
Brass PVD	11800235
Satin Nickel PVD	11800238
Dark Bronze	11800231
Matte Black	11800179

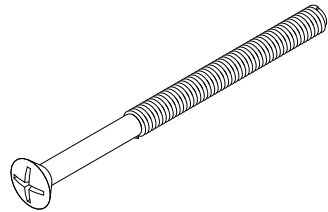

Spindle/Spindle Extension Kit

Includes:

- 1 - 2 pc. Spindle
- 2 - Set screws

Length	PN
5.06"	18900393

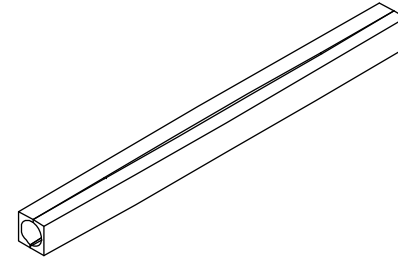

Lever Bushing, Traditional

Color	PN
Clear	02062201
Gray	10148448
Gold	10148447
Natural	02062202
Black	10148020

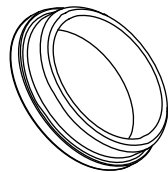

Lug Seal

PN
00142046

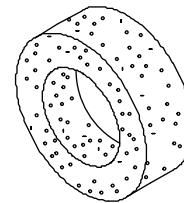

Contemporary Handle, Exterior, Active, Keyed

Includes:

- 1 - Handle
- 1 - Exterior escutcheon with bushing
- 1 - Keyed cylinder, includes 2 keys
- 2 - Lug seals
- 1 - Spring cartridge
- 1 - Set screw
- 1 - Installation instruction
- 1 - Hex wrench

LH Outswing Panel uses RH PN RH Outswing Panel uses LH PN		
Color	LH PN	RH PN
Matte Black	11870120	11870112
Satin Nickel PVD	11870122	11870114
Oil Rubbed Bronze PVD	11870124	11870116
Dark Bronze	11870126	11870118

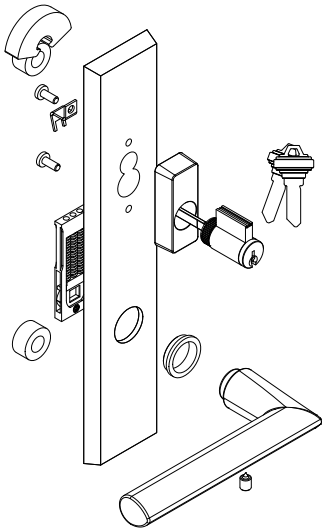

LH shown

Contemporary Handle, Interior, Active, Keyed

Includes:

- 1 - Handle
- 1 - Interior escutcheon with bushings
- 1 - Spring cartridge
- 1 - Thumb turn
- 2 - Machine screws, 2 1/4" Doors
- 2 - Machine screws, 1 3/4" Doors
- 1 - Split spindle, 2 1/4" Doors
- 1 - Split spindle, 1 3/4" Doors
- 1 - Set screw
- 1 - Installation instruction
- 1 - Hex wrench

LH Outswing Panel uses LH PN RH Outswing Panel uses RH PN		
Color	LH PN	RH PN
Matte Black	11870104	11870097
Satin Nickel PVD	11870106	11870098
Oil Rubbed Bronze PVD	11870108	11870100
Dark Bronze	11870110	11870102

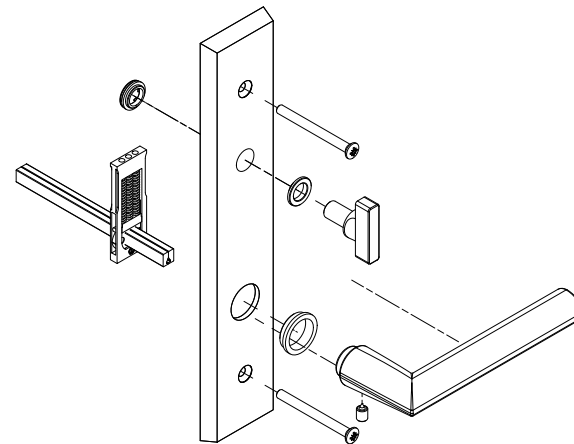

RH shown

Contemporary Handle, Interior, Active, Non-Keyed

Includes:

- 1 - Handle
- 1 - Interior escutcheon with bushings
- 1 - Spring cartridge
- 1 - Thumb turn
- 2 - Machine screws, 2 1/4" Doors
- 2 - Machine screws, 1 3/4" Doors
- 1 - Split spindle, 2 1/4" Doors
- 1 - Split spindle, 1 3/4" Doors
- 1 - Set screw
- 1 - Installation instruction
- 1 - Hex wrench

LH Outswing Panel uses LH PN RH Outswing Panel uses RH PN		
Color	LH PN	RH PN
Matte Black	11870136	11870128
Satin Nickel PVD	11870138	11870130
Oil Rubbed Bronze PVD	11870139	11870132
Dark Bronze	11870143	11870133

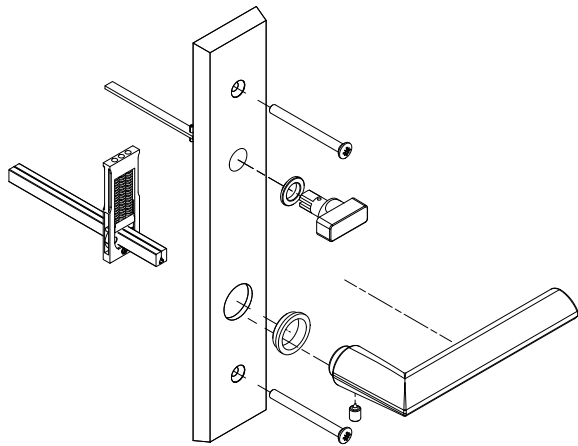

RH shown

Contemporary Handle, Exterior, Non-Keyed, Inactive/Dummy

Includes:

- 1 - Handle
- 1 - Exterior escutcheon with bushings
- 2 - Lug seals
- 1 - Fixing plate
- 1 - Set screw
- 1 - Installation instruction
- 1 - Hex wrench

Contemporary Handle, Interior, Inactive/Dummy

Includes:

- 1 - Handle
- 1 - Escutcheon with bushing
- 1 - Dummy fixing plate
- 1 - Spring cartridge
- 2 - Machine screws, 2 1/4" Doors
- 2 - Machine screws, 1 3/4" Doors
- 1 - Split spindle, 2 1/4" Doors
- 1 - Split spindle, 1 3/4" Doors
- 1 - Set screw
- 1 - Installation instruction
- 1 - Hex wrench

LH Outswing Panel uses RH PN RH Outswing Panel uses LH PN		
Color	LH PN	RH PN
Matte Black	11870153	11870145
Satin Nickel PVD	11870154	11870146
Oil Rubbed Bronze PVD	11870156	11870148
Dark Bronze	11870158	11870149

LH Outswing Panel uses LH PN RH Outswing Panel uses RH PN		
Color	LH PN	RH PN
Matte Black	11870169	11870160
Satin Nickel PVD	11870171	11870162
Oil Rubbed Bronze PVD	11870172	11870164
Dark Bronze	11870174	11870166

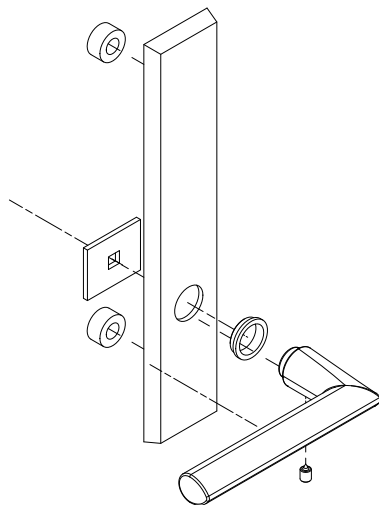

LH shown

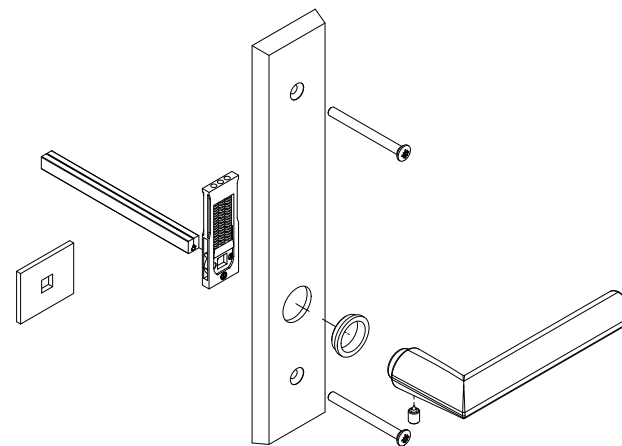

RH shown

Thumb Turn, Contemporary

For Keyed Handle

Includes:

- Thumb Turn Washer
- Thumb Turn Push Nut

No Tail Piece/Actuator (for keyed handle)	
Color	PN
Oil Rubbed Bronze PVD	10148485
Satin Nickel PVD	10148487
Dark Bronze	10148479
Matte Black	10148480

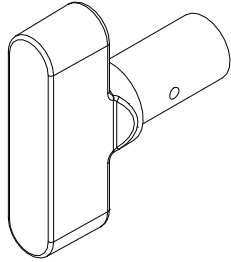

Thumb Turn, Contemporary with Actuator/Tail Piece

For Non-Keyed Handle

Includes:

- Actuator/Tailpiece
- Thumb Turn Washer
- Thumb Turn Push Nut

With Tail Piece/Actuator (for non-keyed handle)	
Color	PN
Oil Rubbed Bronze PVD	10148497
Satin Nickel PVD	10148499
Dark Bronze	10148491
Matte Black	10148492

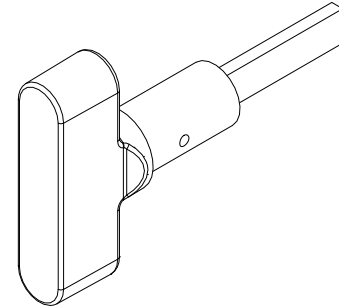

M5 x 65mm Oval Head Machine Screw

Color	PN
Oil Rubbed Bronze PVD	10148456
Satin Nickel PVD	10148457
Dark Bronze	10148455
Matte Black	11800694

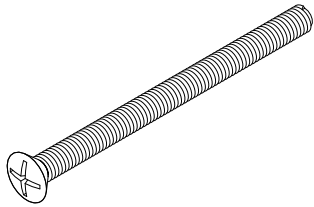

Handle Extension

Color	PN
Oil Rubbed Bronze PVD	10148421
Satin Nickel PVD	10148422
Dark Bronze	10148420
Matte Black	10148445

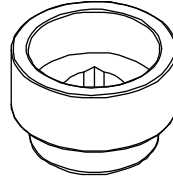

Spindle Kit

Includes:

- 1 - 2 pc. Spindle
- 2 - Set screws

NOTE: Longer length spindles are intended for use with the 3/4" Handle Extension.

2 1/4" Panels	
Length	PN
5 1/8"	10148458
5 29/32"	10148459

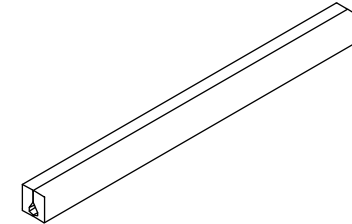

Spring Cartridge

PN
10830452



Lever Bushing, Contemporary

Color	PN
Gray	10148448
Natural	02062202
Black	10148020

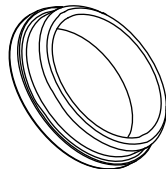

Gasket Post, Lug Seal

PN
10148404

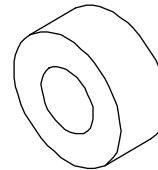

Gasket, Top Backplate

PN
10148405

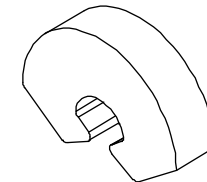

Keyed Cylinder, Lock

(Schlage "C" Keyway)

For service replacement only.

Includes:

2 - Keys

NOTE: For Keyed Alike orders, use program C87P2

Polished Chrome, White, Satin Nickel PVD, Matte Black use
Chrome Face

Satin Taupe, Antique Brass, Satin Chrome, Oil Rubbed
Bronze, Oil Rubbed Bronze PVD, Brass PVD, Dark Bronze
use Brass Face

Color	PN
Brass Face	10830212
Chrome Face	10830209

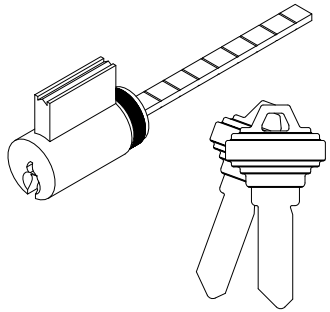

Handle Assembly, Active Panel

Includes:

- 1 - Interior lever with spindle, escutcheon plate and hardware (A)
- 1 - Exterior lever with escutcheon plate and hardware (B)
- 1 - Thumb turn with hardware (C)
- 1 - Keyed cylinder with housing and hardware, includes 2 keys (D)
- 1 - Exterior escutcheon plate gasket (E)
- 1 - Exterior escutcheon plate (F)
- 1 - Two piece spindle (G)
- 2 - M5 x 65mm Phillips oval head machine screws (H)
- 1 - Interior escutcheon plate (I)
- 1 - Thumb turn washer (J)
- 1 - Thumb turn push nut (K)

Color	PN
Satin Taupe	21448121

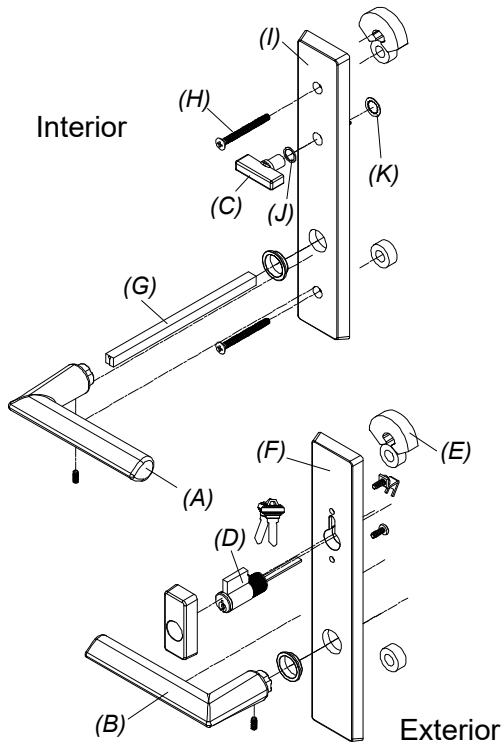

Handle Assembly, Inactive

Includes:

- 1 - Interior lever with spindle, escutcheon plate and hardware (A)
- 1 - Exterior lever with escutcheon plate and hardware (B)
- 1 - Exterior escutcheon plate gasket (C)
- 1 - Exterior escutcheon plate (D)
- 1 - Two piece spindle (E)
- 2 - M5 x 65mm Phillips oval head machine screws (F)
- 1 - Interior escutcheon plate (G)

Color	PN
Satin Taupe	21448125

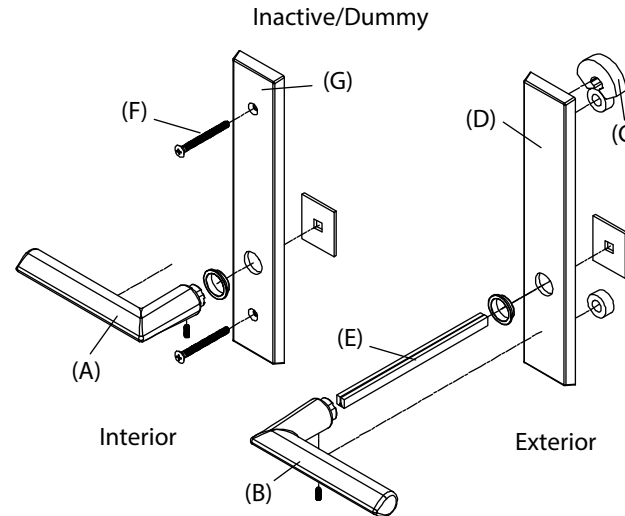

3/4" Handle Extension

Requires 3/4" Spindle Extension

Color	PN
Satin Taupe	10148419

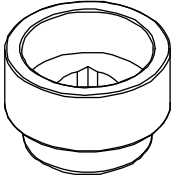

M5 x 65mm Phillips Oval Head Machine Screw

Color	PN
Satin Taupe	10148454

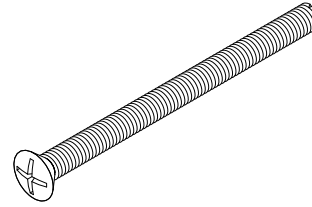

**NOTE: Always view units
from the exterior for handing.
H=Hinge location**

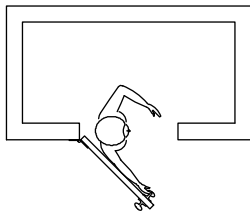

RH Outswing

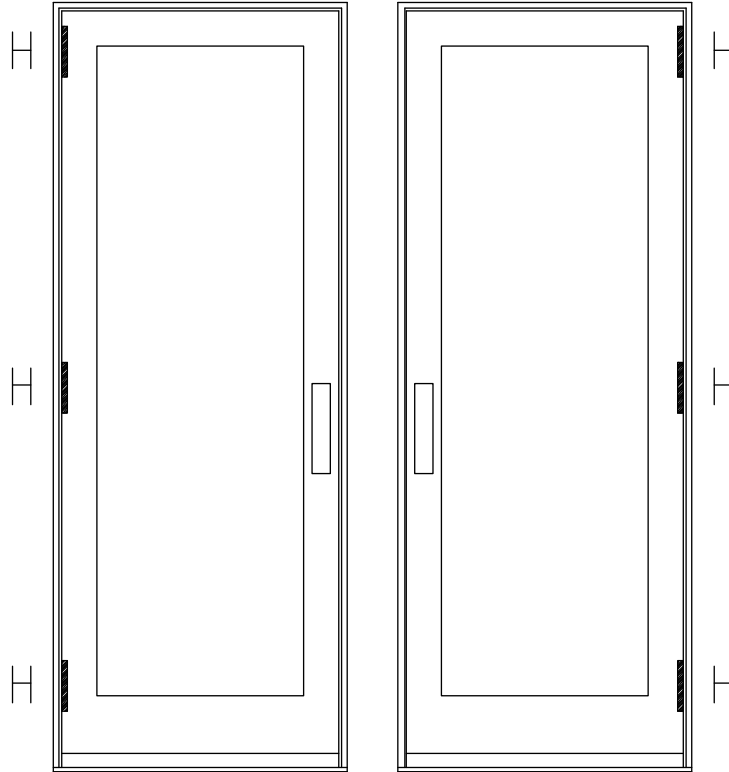

X-RH Outswing
This panel uses the
right hand hinge

X-LH Outswing
This panel uses the
left hand hinge

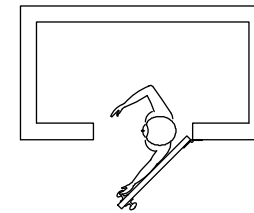

LH Outswing

Hinge Kit, Adjustable

Includes:

- 1 - Adjustable hinge
- 1 - #10 x 2 1/2" Phillips flat head wood screws (jamb)
- 5 - #10 x 3/4" Phillips flat head wood screws (jamb, stationary stile)
- 4 - #8 x 1 1/2" Phillips flat head wood screws (panel)

NOTE: Hinge part number includes the color matched screws, If you need to order the screws separately, they are listed below.

Adjustment Cover, Adjustable Hinge

PN
11844039

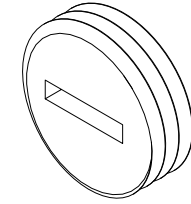

Adjustable Hinge Package - Color and Part Number			Matching Screw Color
Hinge Color	LH PN	RH PN	
Satin Taupe (TP)	02101216	02101227	TP
Goldtone (GT)	02101213	02101224	GT
Silver Frost (SF)	02101218	02101229	Stainless Steel
Dark Bronze (DKBZ)	02101217	02101228	DKBZ
Antique Brass (AB)	02101210	02101221	DKBZ
White (WH)	02101214	02101225	WH
Satin Chrome (SC)	02101212	02101223	Stainless Steel
Oil Rubbed Bronze (ORBZ)	02101219	02101230	DKBZ
Oil Rubbed Bronze PVD (ORBZ)	02101211	02101222	DKBZ
Brass PVD (BS)	02101215	02101226	BS PVD
Satin Nickel (SN) PVD	02101220	02101231	Stainless Steel
Polished Chrome (PC)	02101234	02101235	Stainless Steel
Matte Black (MBK)	02101236	02101237	MBK

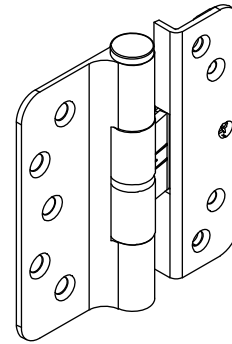

LH Hinge

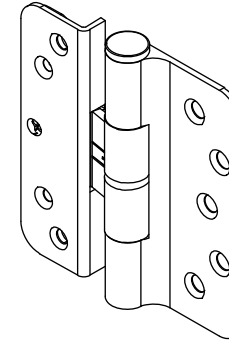

RH Hinge

Individual Screw Description	Color and Part Number							
	TP	GT	WH	DKBZ	BS PVD	Stainless Steel	Chrome	MBK
#8 x 1 1/2" Phillips flat head wood screws (panel). 4 - per hinge.	11865177	11865172	11865173	02058013	11865176	11865175		11865178
#10 x 3/4" Phillips flat head wood screws (jamb) (stationary stile). 5 - per hinge.	11800674	11800670	11800671	11800669	11800673		11800672	11800677
#10 x 2 1/2" Phillips flat head wood screws (jamb). 1 - per hinge.	11800653	11800632	11800637	11800644	10148185	11800639		11800696
NOTE: Part numbers for these screws are sold in packages of 4 screws and includes 1 - 5/32" Allen wrench. (Long Hinge Screw Package)								

Hinge 4 1/2" x 4 1/2" Ball Bearing

Includes:

- 1 - Hinge
- 6 - #12 x 1" Phillips flat head wood screws
- 2 - #12 x 2 1/2" Phillips flat head screws

NOTE: Hinge part number includes the color matched screws, if you need to order the screws separately, they are listed below.

Hinge Color	PN
Stainless Steel	02100162
Satin Chrome / Brass	02101166
Bronze / Brass	02101167
Brass	02101165

Screw Description	Color	PN
#12 x 1" Phillips flat head wood screws	Stainless Steel	02056069
	Dark Bronze	02056010
	Brass	02056068
#12 x 2 1/2" Phillips flat head screws	Stainless Steel	02010311
	Dark Bronze	02056067
	Brass	02010310

Hinge Color	Screw Color
Stainless Steel	Stainless Steel
Satin Chrome / Steel	
Satin Chrome / Brass	Dark Bronze
Bronze / Steel	
Bronze / Brass	Brass
Brass	

SC = US26D
BZ = US10A
BS = US3
SS = US32D

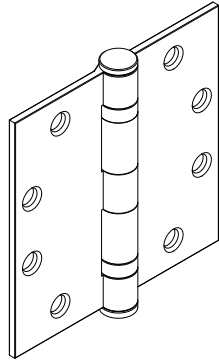

4 1/2" x 4 1/2" Hinge Shim

PN
18900502

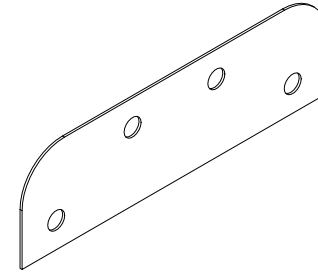

Locking Rod Assembly, Top Multi-Point Lock

Height	Top Locking Rod Length	Color	PN
CN 8-0 ht	51 7/16"	Stainless Steel	05700179
CN 10-0 ht	75 7/16"		05700196

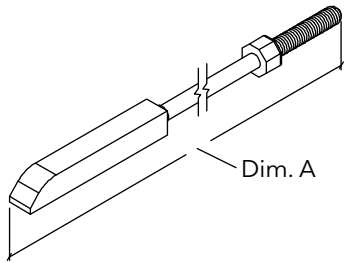

Locking Rod Assembly, Bottom Multi-Point Lock

Solid stainless steel rod with 1/4" - 20 threads

Bottom Locking Rod Length	Color	PN
34 3/4"	Stainless Steel	10815179

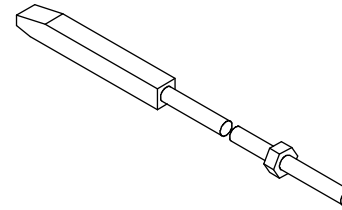

Strike Plate, Sill/Head Jamb

NOTE: Used at Head Jamb

PN
10815201

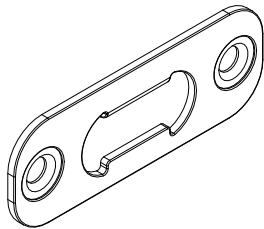

#10 x 3" Phillips Flat Head Screws

For Strike Plate, Sill/Head Jamb

Color	PN
Stainless Steel	02056011

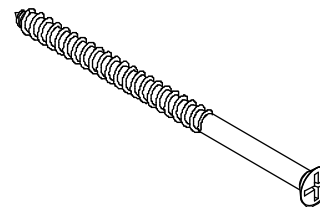

Head Strike

RT2 one wide

Includes:

- 1 - Strike
- 2 - #10 x 3" Phillips flat head screws

PN
05700319

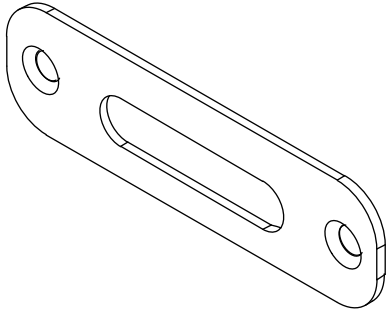

Shoot Bolt, Beveled

RT2 one wide

PN
10815101

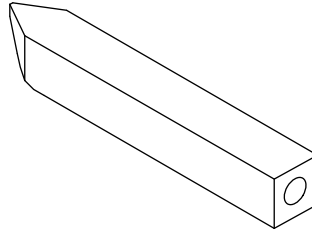

Shoot Bolt Guide

Includes:

- 1 - Shoot bolt guide
- 1 - #8 x 1 1/2" Phillips pan head wood screw

PN
10815199

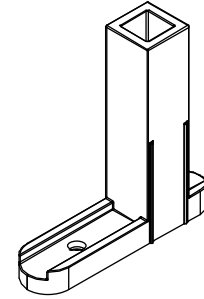

Sill Strike Backer Plate

PN
10148009

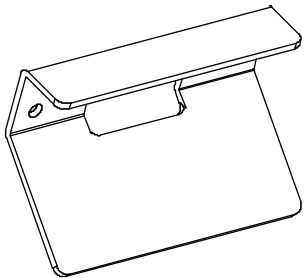

Stile End Plate

Handing	PN
LH	10148008
RH	10148007

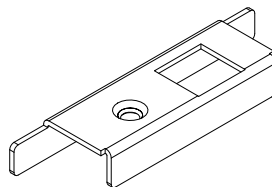

Header Reinforcement Bracket

Color	PN
Stainless Steel	11100249

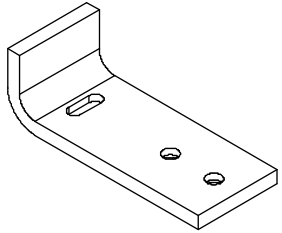

#8 x 1" Phillips Flat Head Screw

For Header Reinforcement Bracket

Color	PN
Stainless Steel	11800645

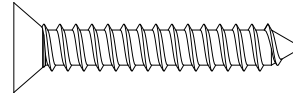

Sill Strike Backer Plate

PN
10148006

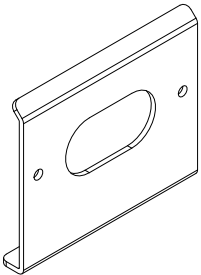

Sill Strike, IZ3

PN
10148005

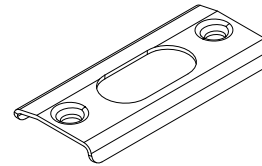

Pkg, Panel Strike Plate

Mortise Lock or Multi-Point Lock

Includes:

- 1 - Panel strike plate, Stainless Steel (05700049), Antique Brass (05700044), Oil Rubbed Bronze PVD (05700117) and Brass PVD (10148176)
- 2 - #8-18 x 1" Type AB, Full thread, Phillips flat head screws, Stainless Steel (11800645), Dark Bronze (11800652) and Brass PVD (11800536)

Note: Dark Bronze screws are used with Antique Brass and Oil Rubbed Bronze PVD

Color	PN
Stainless Steel	05700312
Antique Brass	05700313
Oil Rubbed Bronze PVD	05700314
Brass PVD	10148183

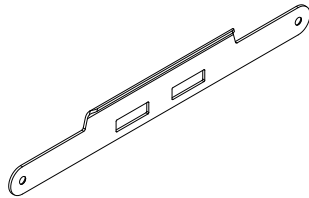

Cover Plate

Active Mortise Lock or Multi-Point Lock

Includes:

- 1 - Cover plate
- 2 - #8-18 x 1" Type AB, Full thread, Phillips flat head screws, Stainless Steel (11800645), Dark Bronze (11800652) and Brass PVD (11800536)

Color	PN
Stainless Steel	05700306
Antique Brass	05700307
Oil Rubbed Bronze PVD	05700308
Brass PVD	10148179

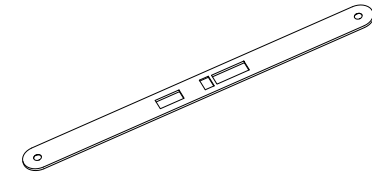

Strike Plate, Jamb

Mortise Lock or Multi-Point Lock

Includes:

- 1 - Jamb strike plate
- 2 - #8-18 x 1" Type AB, Full thread, Phillips flat head screws, Stainless Steel (11800645), Dark Bronze (11800652) and Brass PVD (11800536)

Color	PN
Stainless Steel	05700309
Antique Brass	05700310
Oil Rubbed Bronze PVD	05700311
Brass PVD	10148182

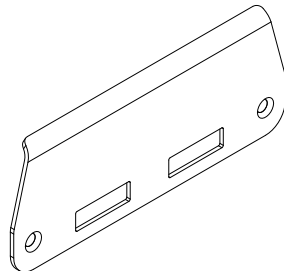

Mortise Lock, Active Multi-Point Lock

(Latch, dead bolt and head/foot shoot bolts)

PN
05700130

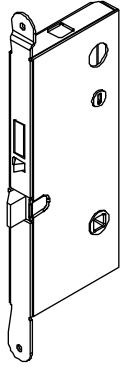

Mortise Lock, Inactive Panel Multi-Point Lock

(Head/foot shoot bolts)

PN
05700131

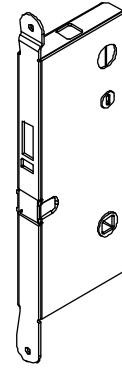

Jamb Spacer Tack, Stationary Panel

3/4" Diameter Head

PN
11860423

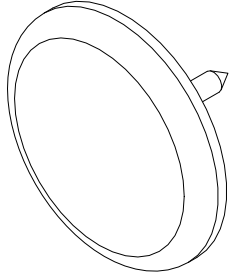

Head Jamb Spacer Tack, Stationary Panel

PN
11860424

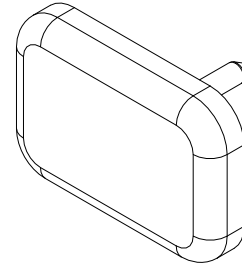

Sill Bolt, Stationary Panel

Includes:

2- #8 x 3" Phillips flat head wood screw (11800830)

Color	PN
Zinc Die Cast	11101856

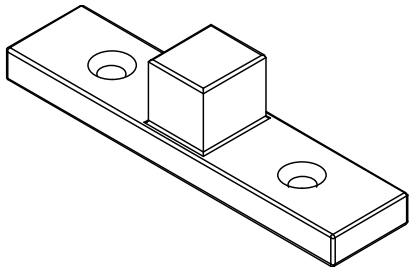

Shim, Head Jamb Strike

Usage dates:

Prior to 8/31/2009

PN
11100251

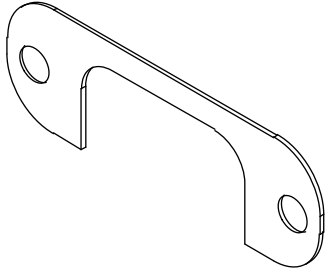

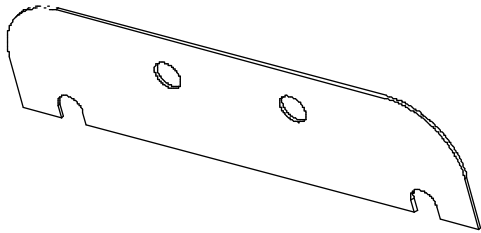

4 1/2" x 4 1/2" Hinge Shim Ultimate Frame

No Availability. Use current part.

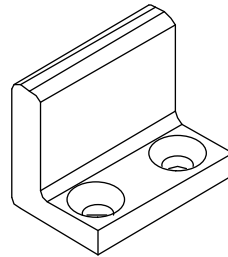

Header Reinforcement Bracket

No Availability. Use current part.
Usage dates: Prior to 8/31/2009

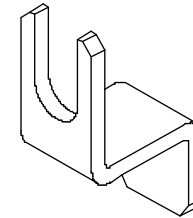

Stop clip with screws

No Availability.

When ordering replacement parts, specify:

1. Profile number;
2. Rough opening;
3. Length;
4. Handing;
5. Finish (where applicable),



Panel Drip, Outswing, A2408

When ordering replacement parts, specify:

1. Profile number;
2. Rough opening;
3. Length;
4. Handing;
5. Finish (where applicable),

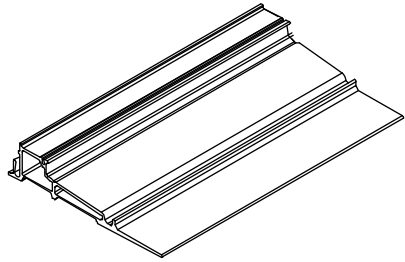

Ultrex Sill, 6 9/16" Jamb, F257

Available in Beige or Bronze

Connecting Barb

V803

NOTE: Color may vary depending on current stock.

Length	PN
Specify Length L/F	15812999

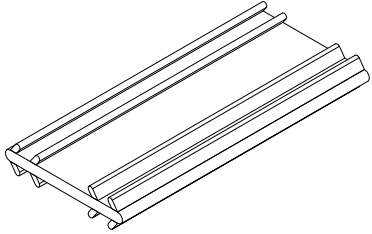

When ordering replacement parts, specify:

1. Profile number;
2. Rough opening;
3. Length;
4. Handing;
5. Finish (where applicable),

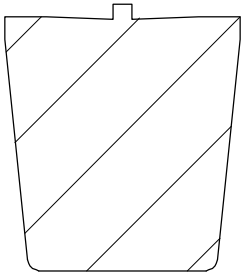

Mull Casing, W8775

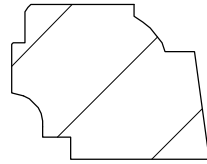

Glazing Cap, W9949

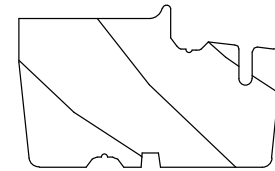

First Mull Casing and Astragal, W1445

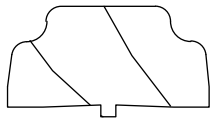

**Astragal Cover and Transom Mull Cover,
W7554**

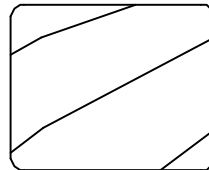

Stationary Sweep Filler, Outswing, W12495

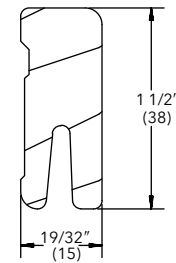

Sill Liner (Oak), Outswing, W2528

When ordering replacement parts, specify:

1. Profile number;
2. Rough opening;
3. Length;
4. Handing;
5. Finish (where applicable),

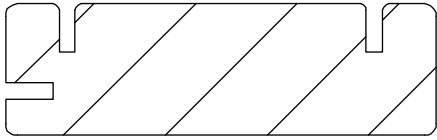

Part Stop, Outswing, W10401

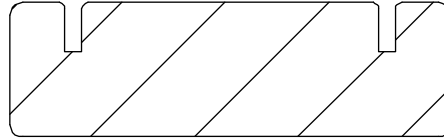

**Radius (RT6) Head Jamb Part Stop Outswing,
W9983**

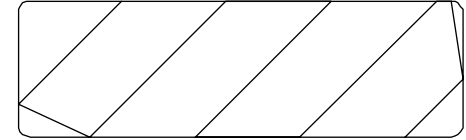

**Radius (RT2) Head Jamb Part Stop,
Outswing, W9951**

When ordering replacement parts, specify:

1. Profile number;
2. Rough opening;
3. Length;
4. Handing;
5. Finish (where applicable),

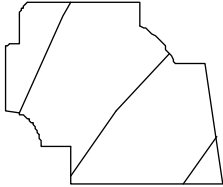

Glazing Cap, W4019

Weather Strip, Frame

V1707

Length	Color	PN
120"	Beige	11191299
	Black	11191399

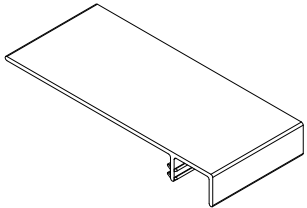

Offset Bulb Weather Strip, Parting Stop, Frame, Mull Casing, Transom and Astragal

V796

Length	Color	PN
75 43/64"	Beige	15170866
	Black	15170867
104 7/8"	Beige	15170090
	Black	15170091
115 41/64"	Beige	15170810
	Black	15170811
189 11/16"	Beige	15173298
	Black	15173398

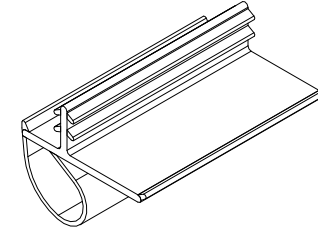

Weather Strip, Frame

V1732

Length	Color	PN
150"	Beige	11191499
	Black	11191599

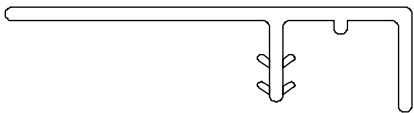

Weather Strip, Frame

V1733

Length	Color	PN
151"	Beige	11191699
	Black	11191799

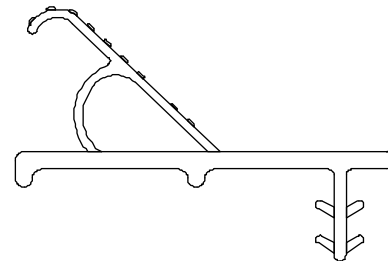

Sweep, Active and Inactive Panel

V2416

Length	Beige PN	Black PN
70 1/2"	11181870	11181871

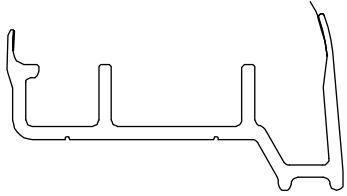

Sweep, Stationary Panel

V2427

Length	Beige PN	Black PN
70 1/2"	11181798	11181799

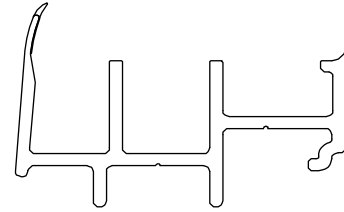

Weather Strip, Panel Cover

V018

Length	Beige PN	Black PN
150"	11198799	11198999

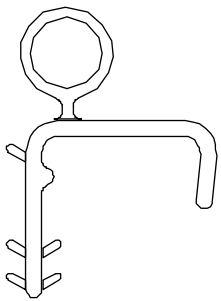

Weather Strip, Inactive Panel

V1706

Length	Beige PN	Black PN
121"	15618199	15618299



Weather Strip, Sill

V1659

Length	Beige PN	Black PN
35 17/64"	11197030	11197130
41 17/64"	11197036	N/A
70 29/64"	11197060	11197160
82 29/64"	11197070	11197170
150"	11197099	11197199

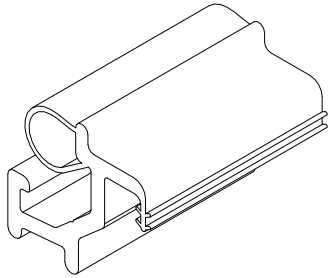

Weather Strip, Stile

V020

Length	Beige PN	Black PN
79 9/16"	11197968	N/A
92 15/16"	11197982	N/A
150"	11197999	11197998

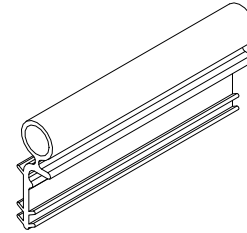

Dust Block, Part Stop

1 3/8" x 3/8" x 1/2"

Color	PN
Gray	15600010
Beige	15600011

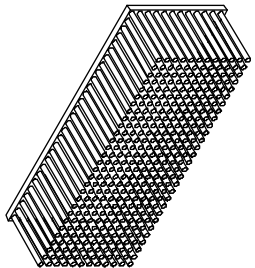

Dust Block, Astragal or Panel

1 3/8" x 1/4" x 1/2"

PN
10500049

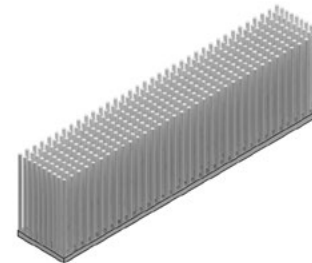

Sweep, Stationary Panel

V1657

Usage dates:

Pre 6-03-2015

Length	Beige PN	Black PN
150"	11181399	11181499

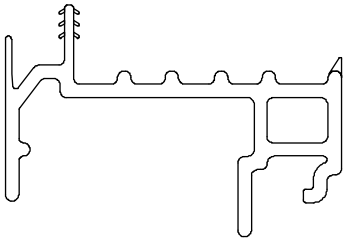

When ordering replacement panels, specify:

NOTE: Weather strip is included with all panels (where applicable).

1. OM of panel (NOTE: OM of panel does not include astragal, mull casing or sweep);
2. Active, Inactive or Stationary;
 - a. Active - comes prepped for multi-point mortise lock and standard Marvin handle set. If Marvin Architectural Hardware prep is needed, specify brand.
 - b. Inactive - comes prepped for multi-point lock and standard Marvin handle-set. If Marvin Architectural Hardware prep is needed, specify brand.
 - c. Stationary - specify configuration and astragal or mull casing (if applicable).
 - d. Panel style
3. Handing;
4. Glazing;
5. Finish;
6. Glazing bead profile
 - a. bevel
 - b. square.
 - Active panels include panel sweep and multi-point mortise lock system.
 - Inactive panels include sweep, astragal, and multi-point lock system.
 - Stationary 1 wide panels include panel sweep.

