

Elevate 1/2" Horizontal MRF Mull Kit-ELDH/P/TR, ELALDGRT-DH above Mull Field Application Instruction

Before You Begin

- This instruction is intended for use when an Elevate horizontal MRF Mull Kit on a ELDH/P/TR, ELALDGRT-DH above Mull for field applied mulling
- More than one mull kit may be necessary. Field mulls beyond factory mull configurations are not recommended.
- When specifying or considering the structural load requirements for windows and doors, it is important to consider the method of fastening the unit(s) together in addition to the method of fastening multiple assemblies into an opening. The methods contained herein may not be appropriate for all performance requirements. Selection of the appropriate fastening method(s) is the sole responsibility of the installer, contractor, structural engineer, architect, building owner and/or installer.
- Do not stack Elevate Gliders.
- For assembly limitations beyond factory configuration sizes, contact your local Marvin dealer.
- Please read through these instructions thoroughly and in their entirety before attempting to mull windows.

IMPORTANT

Read these instructions thoroughly before beginning to assemble any multiple Elevate units. Failure to assemble as recommended will void any warranty, written or implied. Refer to specific product installation instructions for proper installation methods.



WARNING!

This product can expose you to chemicals including titanium oxide, which is known to the state of California to cause cancer. For more information, go to www.P65Warnings.ca.gov.



WARNING!

This product can expose you to chemicals including methanol, which is known to the state of California to cause birth defects or other reproductive harm. For more information, go to www.P65Warnings.ca.gov.



WARNING!

Drilling, sawing, sanding or machining wood products can expose you to wood dust, a substance known to the State of California to cause cancer. Avoid inhaling wood dust or use a dust mask or other safeguards for personal protection. For more information go to www.P65Warnings.ca.gov/wood.



WARNING!

Always practice safety! Wear the appropriate eye, ear, and hand protection, especially when working with power tools.

You Will Need to Supply

- Safety glasses
- Hearing protection
- Hacksaw
- 3/16" Crown x 1" leg 18 gauge staples with staple gun
- Phillips screwdriver
- Hammer
- Power Drill
- Diamond abrasive blade
- ASTM C920 Grade NS class 25 sealant with gun
- 1/4" drill bit
- Clamps
- 3/16" Drill bit
- 1/2" Crown x 1" leg 16 gauge staples with gun
- 4 1/4" clear vinyl tape or similar product

Parts shipped with kit:

Part Cut Lengths
1/2" Mulling Pin: Length = Assembly Height – 1 7/16"
Mull Weatherstrip: Cut each piece to fit as instructed in the procedures below.
1/2" MRF w/ Tape: Length = Assembly Height – 1 7/16"
Mull Cover w/ Tape: Length = Assembly Width
ELALDGRT Mull Support: Length = Assembly Height – 3/4"
ELDH-ELDH Mull Support: Length = Assembly Height – 3/4"
Continuous Drip Cap: Length = Assembly Width + 1/16"

1/2" Horizontal MRF Mull Kits - ELDH/P/TR, ELALDGRT-DH above Mull		
Components for 1/2" Horizontal MRF Mull Kits - ELDH/P/TR, ELALDGRT-DH above Mull - Lineal parts for kits are 96" long		
Description	Base kit quantity	Extra quantities needed or additional mulling
End Plug 1/2" Space Mull Part # 11860389	2 per kit	2 Extra plugs ordered separately per additional mull
A3134 Mulling Pin, 1/2" Space Mull 2 X 96" (2438)	2 per kit	
V2789 Mull Weather Strip, 1/2" 96" (2438)	1 per kit	
PUR with 1 1/2" Tape 96" (2438) *a diamond abrasive blade is	1 per kit	
V2787 Mull Cover (w/Glazing Tape) 96" (2438)	1 per kit	
Center Plug Part #11860388	1 per kit	1 extra plug ordered separately per additional mull (when required)
W12870 Mull Support	1 per kit	
ELALDGRT Mull Support	1 per kit	
W1243 Mull Trim 96" (2438)	1 per kit	
W1243 Mull Trim	1 per kit	
Mull Bracket Part #11040358	1 per kit	
#7-19 x 5/8" Bracket Screw Part # 11800743	40 per kit	40 extra screws needed per additional mull
#8 x 1 3/4" End Plug Screw Part # 11808176	2 per kit	2 extra screws needed per additional mull
V119 Continuous Drip Cap 96" (2438)	1 per kit	For assemblies wider than 96", special parts are required
Nail Fin Connector Part #105000213	2 per kit	2 extra connectors are required per additional mull

For more information on parts and part kits, please refer to the Part Manual.

Mulling- Horizontal Mullion on a Single Wide Assembly (Double Hung, Double Hung Picture, Direct Glaze, or Marvin Round Top units)

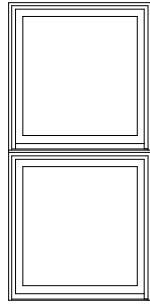

Remove and discard all shipping materials. Inspect the unit to ensure it is the right size, color, etc. and that there is no damage. If you find a discrepancy with your unit, contact your local Marvin representative and provide them with the customer service number located in one of the corners of the glass. See Figure 1.



Figure 1

1. Remove and set aside all screens and loose hardware.
2. Lay frames on a flat surface in the desired mulling configuration (interior, wood side facing up). Remove nailing fin from the head jambs and sills that will be mulled together.
3. Insert one aluminum mulling pin into the kerf of the sill of the upper unit. Ensure mulling pin is roughly 3/4" from either edge of the units.

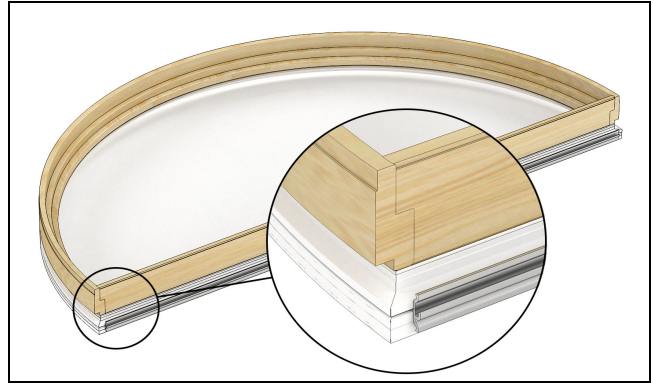

Figure 2

4. Insert the remaining mull in the opposite orientation as the first pin (ex. Hook facing up versus facing down) placing roughly 3/4" off the end of the frame. See Figure 3.



Figure 3

5. Snap the frames together by interlocking the mull pins. Ensure that the pins are seated correctly and the interior unit faces are flush. See Figure 4.



Figure 4

6. Peel back the backing on the tape and dog-ear it, exposing the tape approximately 2". See Figure 5.

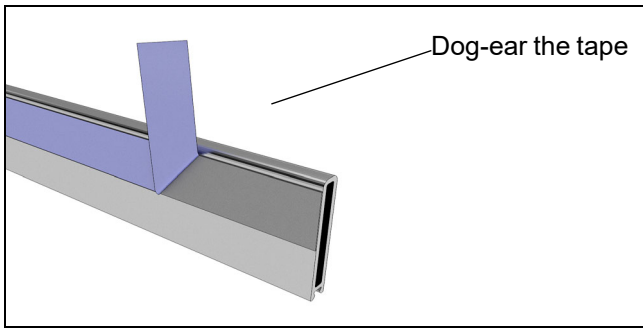

Figure 5

7. Slide the MRF onto the mull pins ensuring the mull pins fit fully into the MRF kerf. See Figure 5.



Figure 6

8. Insert the end plugs into each end of the mull into the MRF. Ensure that the end plug is fully seated into the MRF, the end plug is flush with the end of the frame and the end plug is flush with the exterior face of the units. *NOTE: The MRF may need to be shifted slightly to allow for precise placement. See Figure 7.*



Figure 7

9. Screw #8 x 1 3/4" provided fasteners into the end plugs. See Figure 8.



Figure 8

10. Ensure all components are aligned and then completely remove tape backing from the MRF. See Figure 9.

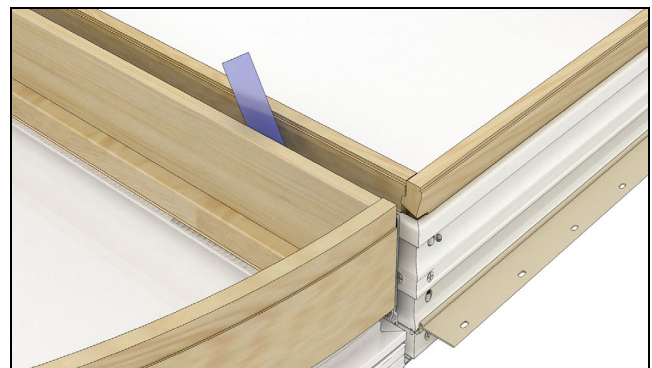

Figure 9

11. Insert mull support on top of the MRF between the cavity of the two frames. Ensure the mull support is flush with the interior plane of the unit frames. For Double Hung-Double Hung configurations, use the ELDH to ELDH Mull Support. See Figure 10. For Marvin Round Top to Double Hung configurations, use the ELALDGRT Mull Support.



Figure 10

12. Lightly clamp the frames together on the interior (use wood blocks to protect interior) near each end to hold the mull units in place. See Figure 11.

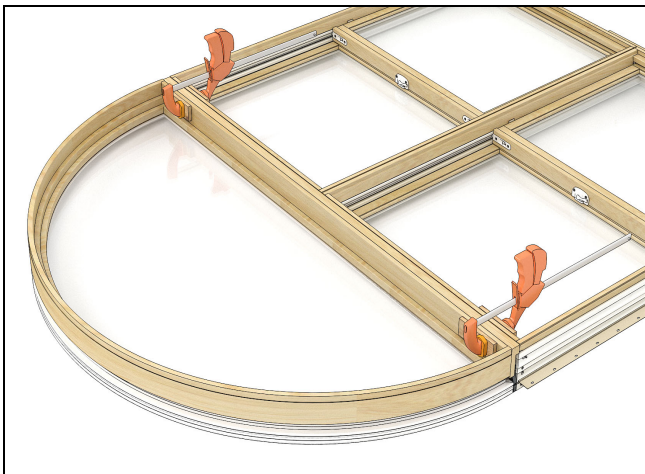

Figure 11

13. Connect the frames to the mull support with two rows of alternatively spaced staples a maximum of 1" from end and 7" on center. See Figure 12.

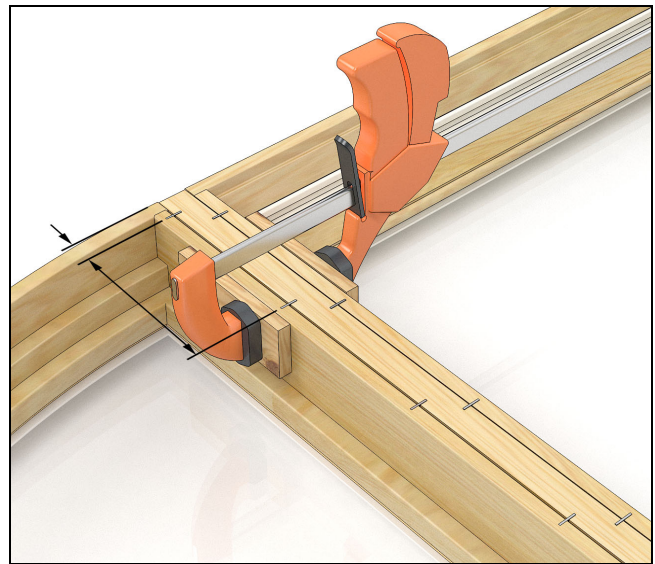

Figure 12

14. Flip unit so exterior side faces upwards. Measure and cut weather strip pieces. Gap between end plugs and weather strip should not exceed 1/8". See Figure 13.



Figure 13

15. Fully seat weather strip pieces onto the aluminum mulling pin between all end plugs. See Figure 14.

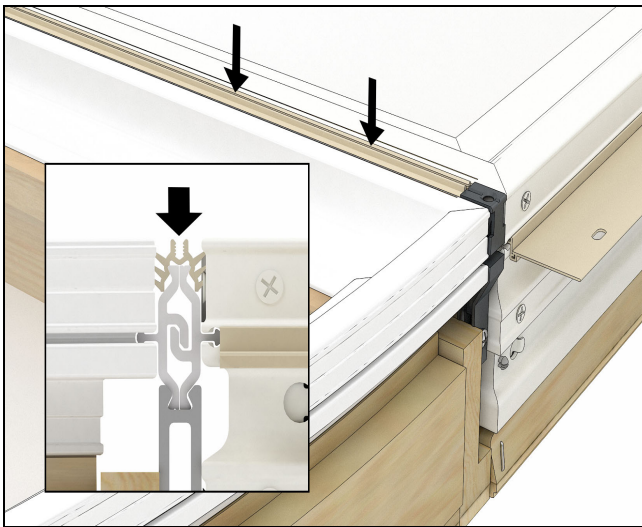

Figure 14

16. Place a piece of clear vinyl tape (or similar) on the frame covering each end plug and ensure tape overhangs at least 2" on each side of plug. See Figure 15.



Figure 15

17. Inject end plugs with sealant until squeeze out reaches ALL specified areas. Avoid placing excess downward pressure on end plugs. See Figure 16.

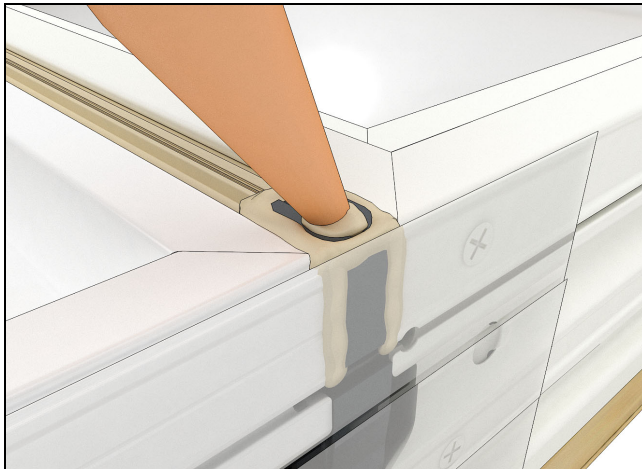

Figure 16

18. Notch ends of the exterior mull cover as seen in Figure 17 1" +/- 1/4" from end.

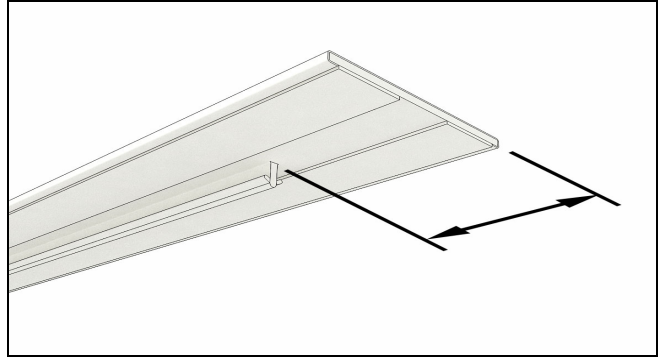

Figure 17

19. Ensure exterior surfaces of frames are clean and dry for optimum tape adhesion. Dog ear both pieces of backing on the tape on the exterior cover on one end. Seat exterior mull cover into the mull weather strip, ensuring the cover is fully seated and the tape is in full contact with window frame surface. See Figure 18.

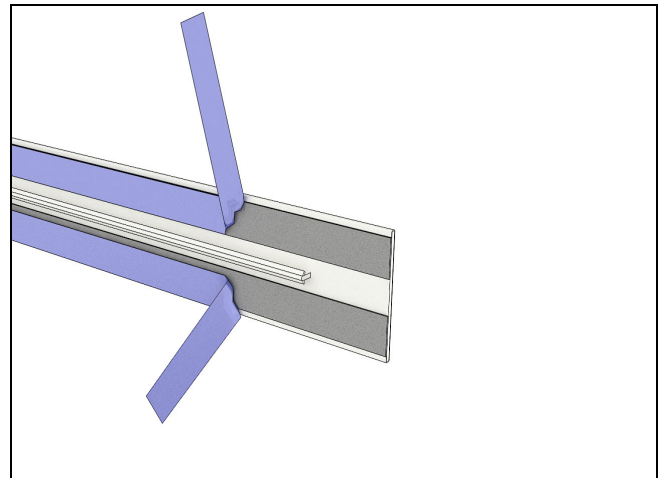

Figure 18

20. Completely remove backing from tape on exterior mull cover. Apply even pressure along the entire length of exterior cover ensuring tape is fully adhered.

21. Install a mull bracket across the head jambs and fasten with four #7-19 x 5/8" bracket screws.



Figure 19

22. Apply continuous drip cap to the header of the assembly. If the entire assembly width is over 96" in length, splice drip cap together in locations offset from the mull joint.

23. Apply nailing fin connector at head jambs and sills centered over the gap between separate nailing fins by

removing the paper backing from the connector and pressing into place. Then seal around the edges with sealant as shown. See Figure 20.

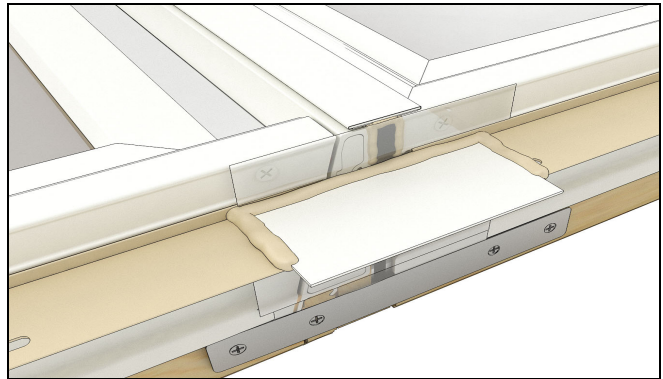
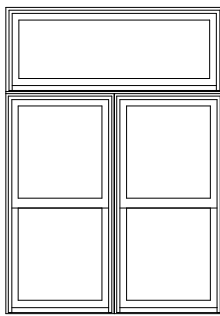

Figure 20

24. If applicable, jamb extension can now be installed. Follow installation instructions for installing unit into rough or masonry opening. *NOTE: Interior mull trim should be applied only after unit is completely installed and interior trim is applied.*

Mulling- Horizontal Continuous Mullion, Double Hung over multi-wide, multi-high units



- For vertical frame-frame mulling procedures, refer to the Elevate Double Hung/Glider Mullion Kit Instructions.

NOTE: Remove all mullion tie blocks on units installed over 1/2" MRF mullion.

Then proceed to step 2 for assembling the horizontal mull.

1. Remove and discard all shipping material. Inspect the unit to ensure it is the right size, color, etc. and that there is no damage. If you find a discrepancy with your windows/doors, contact your local Marvin representative and provide them with the customer service number located in one of the corners of the glass. See Figure 21.



Figure 21

2. Remove and set aside all screens and loose hardware. Lay frames on a flat surface in the desired mulling configuration (interior, wood side facing up). Remove nailing fin from the head jambs and sills that will be mullied together. See Figure 22. *NOTE: Picture shows all nailing fins removed. Only remove nailing fins on jambs/sills that will be mullied together, and any header that will need a continuous drip cap after being mullied together.*

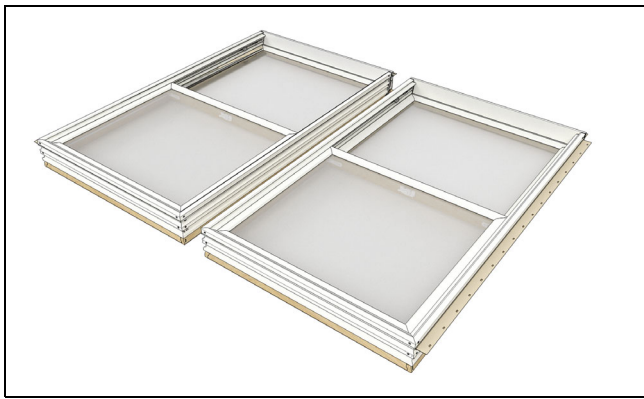

Figure 22

3. When mulling units that contain Frame to Frame Mulls: Apply sealant in nailing fin kerf across mull and down the mull intersection to the exterior face as shown in Figure 23.



Figure 23

4. Insert one aluminum mulling pin into the kerf of the sill of the upper unit. Ensure mulling pin is roughly $\frac{3}{4}$ " from either edge of the units. See Figure 24.



Figure 24

5. Insert the remaining mulling pin in the opposite orientation as the first pin (ex. Hook facing up versus facing down) and place roughly $\frac{3}{4}$ " off either edge of the units. See Figure 25.



Figure 25

6. Snap the frames together by interlocking the mull pins. Ensure that the pins are seated correctly and the interior unit faces are flush. See Figure 26.



Figure 26

7. Peel back the backing on the tape and dog-ear it, exposing the tape approximately 2". See Figure 27.

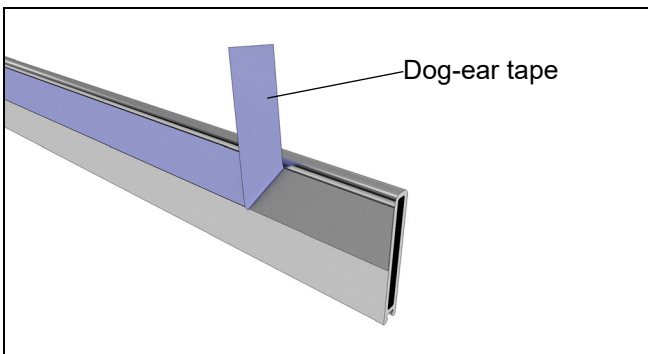

Figure 27

8. Slide the MRF onto the mull pins ensuring the mull pins fit fully into the MRF kerf. See Figure 28.



Figure 28

9. Insert the end plugs into each end of the mull into the MRF. Ensure that the end plug is fully seated into the MRF, the end plug is flush with the end of the frame and the end plug is flush with the exterior face of the units. *NOTE: The MRF may need to be shifted slightly to allow for precise placement. See Figure 29.*



Figure 29

10. Screw #8 x 1 3/4" provided fasteners into the end plugs. See Figure 30.



Figure 30

11. Completely pull out tape backing from the MRF. Insert ELDH-ELDH mull support on top of the MRF between the cavity of the two frames. Ensure the mull support is flush with the interior plane of the unit frames. See Figure 31.



Figure 31

12. Lightly clamp the frames together on interior (use wood blocks to protect interior) near each end to hold the mull units in place. See Figure 32. *NOTE: 2 wide 1 high vertical mull clamping shown. Clamp units together according to the desired configuration.*

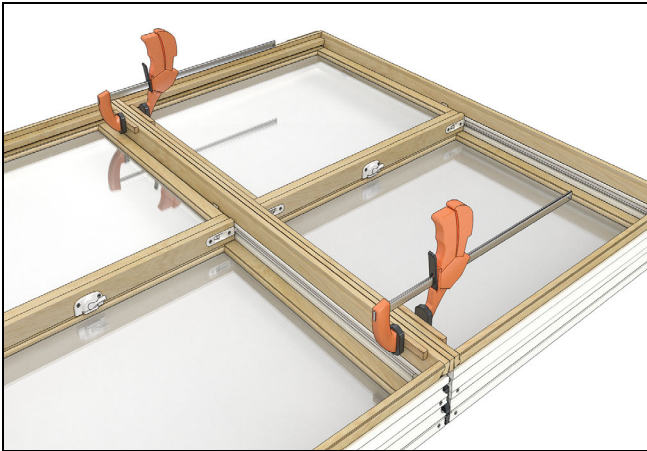

Figure 32

13. Connect the frames to the mull support with two rows of alternatively spaced staples a maximum of 1" from end and 7" on center. See Figure 33.

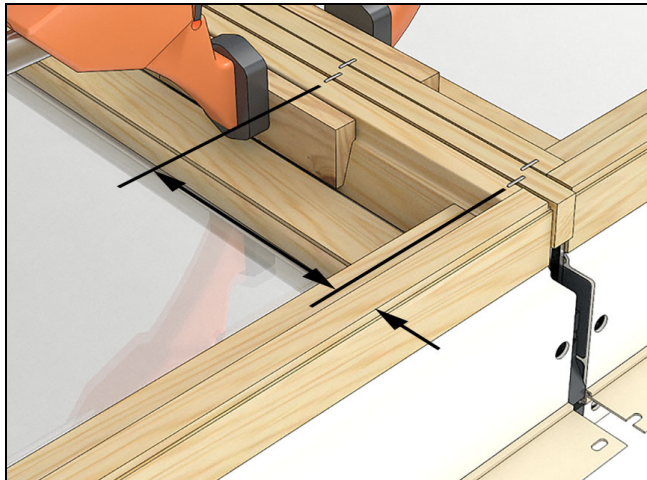

Figure 33

14. Flip unit so exterior side faces upwards. Seat center plug onto mulling pin centered on the mull intersection. Repeat for any other mull intersections. See Figure 34.



Figure 34

15. Measure and cut weather strip pieces. Gap between end plugs and weather strip or center plug and weather strip should not exceed 1/8". See Figure 35.



Figure 35

16. Fully seat weather strip pieces onto the aluminum mulling pin between all end plugs and center plugs. See Figure 36.

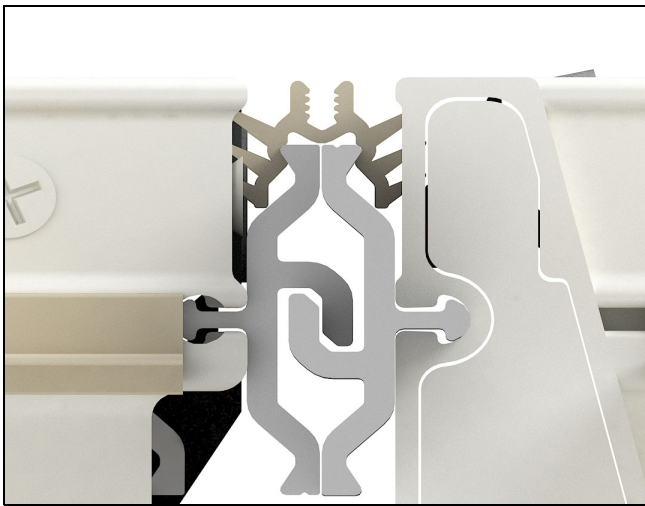

Figure 36

17. Place a piece of clear vinyl tape (or similar) on the frame covering each end plug as shown in Figure 37 and ensure tape overhangs at least 2" on each side of plug.



Figure 37

18. Inject end plugs and center plug with sealant until squeeze out reaches specified areas. Avoid placing excess downward pressure on end plugs. See Figure 38.

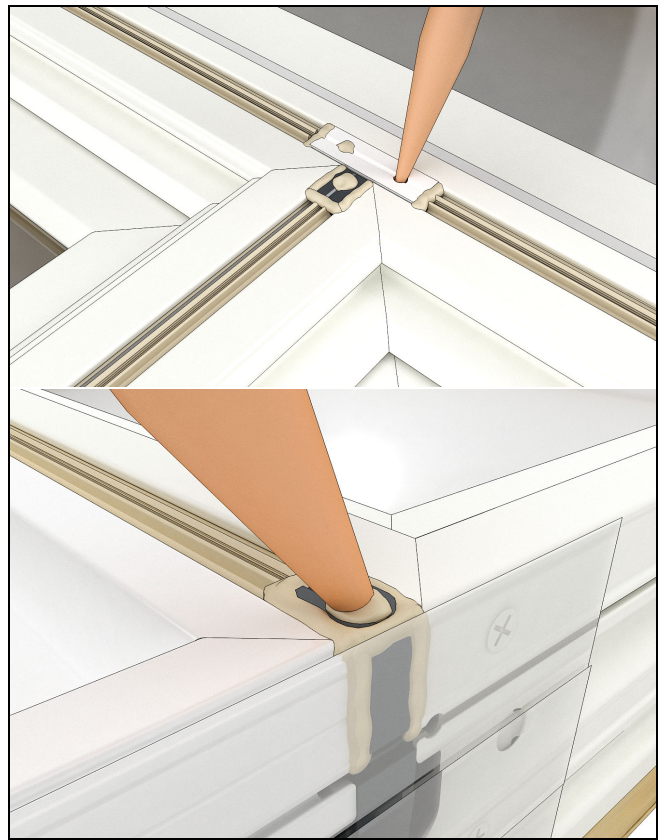

Figure 38

19. Notch exterior mull cover to fit over end plugs by 1" +/- 1/4" from end. Notch the cover to fit over center plugs within 1/4" as seen in Figure 39.

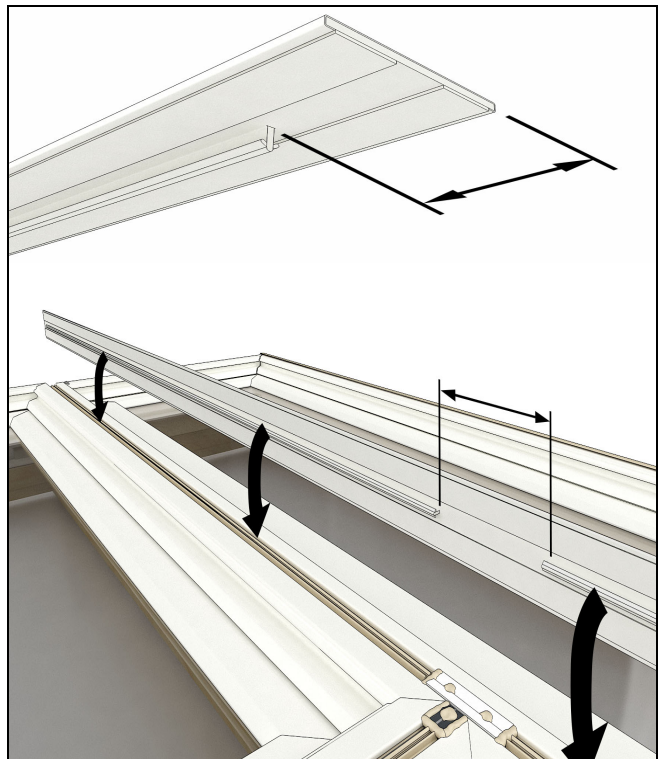

Figure 39

20. Ensure exterior surfaces of frames are clean and dry for optimum tape adhesion.

21. Dog ear both pieces of backing on the tape on the exterior cover on one end. Seat exterior mull cover into the mull weather strip. See Figure 40. Ensure the exterior cover barb is completely seated into the kerf of the weather strip.

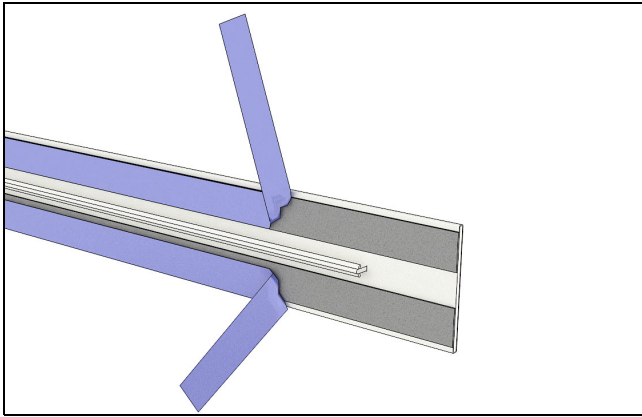

Figure 40

22. Completely remove backing from tape on exterior mull cover. Apply even pressure along the entire length of exterior cover ensuring tape is fully adhered and barb is fully seated.

23. Apply nailing fin connector at the sill (and jambs as needed) centered over the gap between separate nailing fins as needed by removing the paper backing from the connector and pressing into place. Then seal around the edges with sealant as shown. See Figure 41.

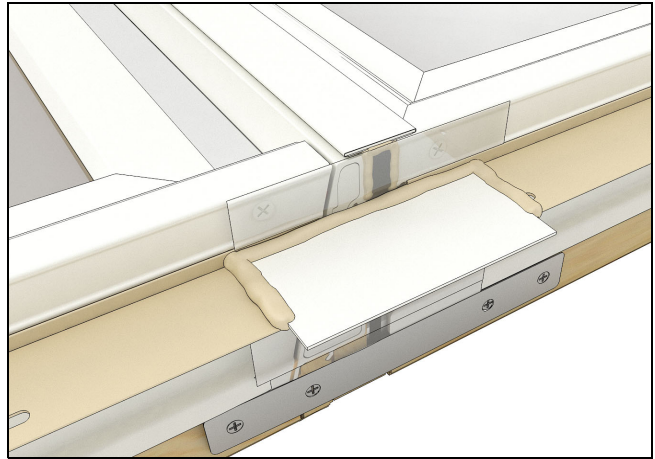
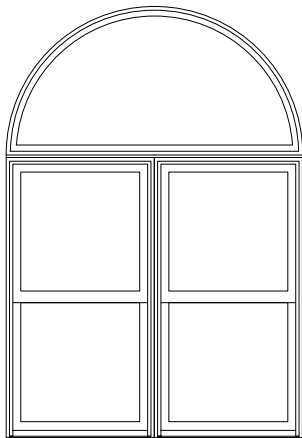

Figure 41

24. If applicable, jamb extensions can now be installed. Follow installation instructions for installing unit into rough or masonry opening. *NOTE: Interior mull trim should be applied only after unit is completely installed and interior trim is applied.*

Mulling- Horizontal Continuous Mullion Marvin Round Top over Multi-wide, Multi-high units



1. Remove and discard all shipping material. Inspect the unit to ensure it is the right size, color, etc. and that there is no damage. If you find a discrepancy with your windows/doors, contact your local Marvin representative and provide them with the customer service number located in one of the corners of the glass. See Figure 42.

- For vertical frame-frame mulling procedures, refer to the Elevate Double Hung/Glider Mullion Kit Instructions.

Then proceed to step 2 for assembling the horizontal mull.



Figure 42

2. Remove and set aside all screens and loose hardware. Lay frames on a flat surface in the desired mulling configuration (interior, wood side facing up). Remove nailing fin from the head jams and sills that will be mulled together. See Figure 43. *NOTE: Picture shows all nailing fins removed. Only remove nailing fins on jambs/sills that will be mulled together, and any header that will need a continuous drip cap after being mulled together.*

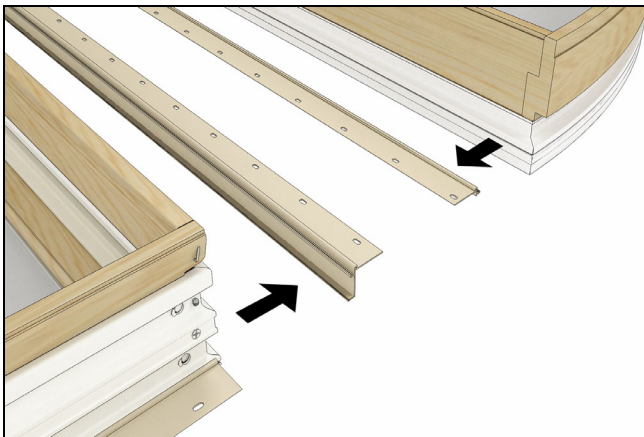

Figure 43

3. When mulling units that contain frame to frame mulls: Apply sealant in nailing fin kerf across mull and down the mull intersection to the exterior face as shown in Figure 44.



Figure 44

4. Insert one aluminum mulling pin into the kerf of the sill of the upper unit(s). Ensure mulling pin is roughly $\frac{3}{4}$ " from either edge of the units. See Figure 45.



Figure 45

5. Insert the remaining mulling pin in the opposite orientation as the first pin (ex. Hook facing up versus facing down) and place roughly $\frac{3}{4}$ " off either edge of the units. See Figure 46.



Figure 46

6. Snap the frames together by interlocking the mull pins. Ensure that the pins are seated correctly and the interior unit faces are flush. See Figure 47.



Figure 47

7. Peel back the backing on the tape and dog-ear it, exposing the tape approximately 2". See Figure 48.

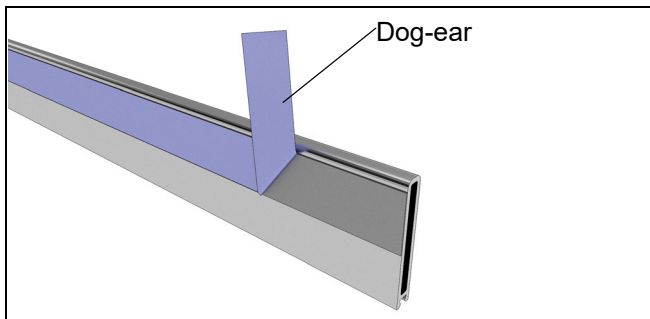

Figure 48

8. Slide the MRF onto the mull pins ensuring the mull pins fit fully into the MRF kerf. See Figure 49.



Figure 49

9. Insert the end plugs into each end of the mull into the MRF. Ensure that the end plug is fully seated into the MRF, the end plug is flush with the end of the frame and the end plug is flush with the exterior face of the units. *NOTE: The MRF may need to be shifted slightly to allow for precise placement. See Figure 50.*



Figure 50

10. Screw #8 x 1 3/4" provided fasteners into the end plugs. See Figure 51.



Figure 51

11. Ensure all components are aligned and completely pull out tape backing from the MRF. Insert ELALDGRT mull support on top of the MRF between the cavity of the two frames. Ensure the mull support is flush with the interior plane of the unit frames. See Figure 52.



Figure 52

12. Lightly clamp the frames together on interior (use wood blocks to protect interior) near each end to hold the mull units in place. See Figure 53. *NOTE: 2 wide 1 high vertical mull clamping shown. Clamp units together according to the desired configuration.*

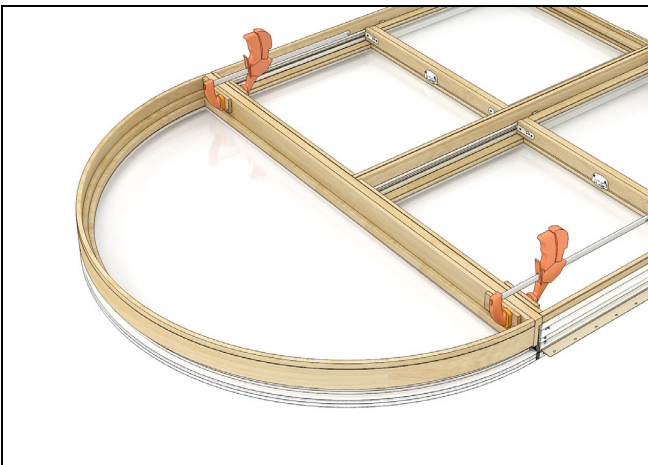

Figure 53

13. Connect the frames to the mull support with two rows of alternatively spaced staples a maximum of 1" from end and 7" on center. See Figure 54.

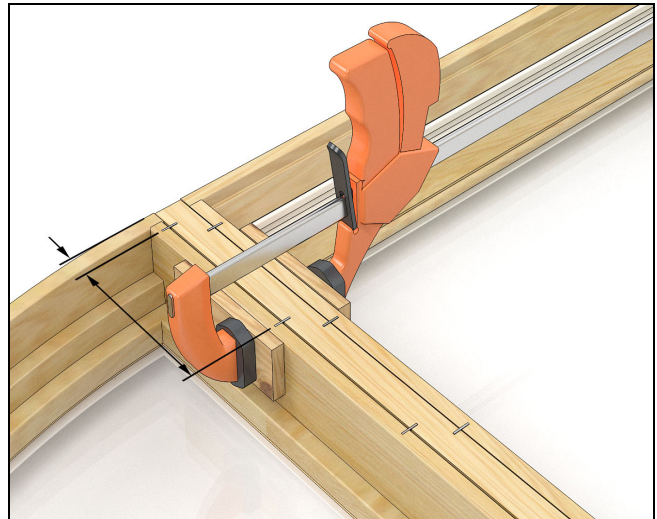

Figure 54

14. Flip unit so exterior side faces upwards. Seat center plug onto mulling pin centered on the mull intersection. Repeat for any other mull intersections. See Figure 55.



Figure 55

15. Measure and cut weather strip pieces. Gap between end plugs and weather strip or center plug and weather strip should not exceed 1/8". See Figure 56.



Figure 56

16. Fully seat weather strip pieces onto the aluminum mulling pin between all end plugs and center plugs. See Figure 57.

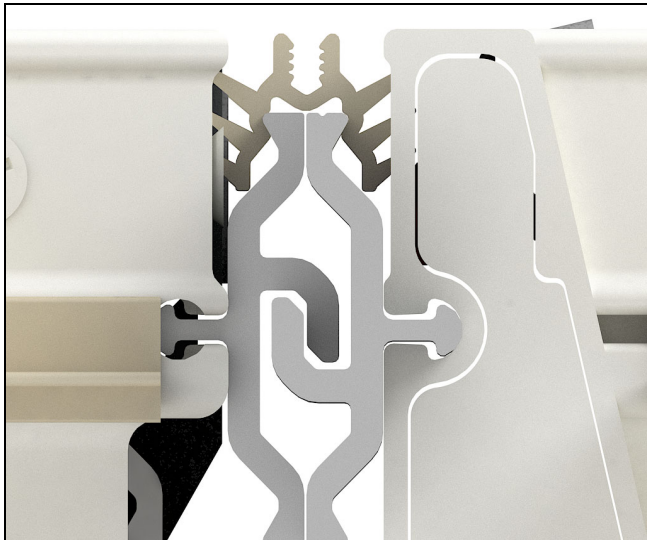

Figure 57

17. Place a piece of clear vinyl tape (or similar) on the frame covering each end plug as shown in Figure 58 and ensure tape overhangs at least 2" on each side of plug.



Figure 58

18. Inject end plugs and center plug with sealant until squeeze out reaches specified areas. Avoid placing excess downward pressure on end plugs. See Figure 59.

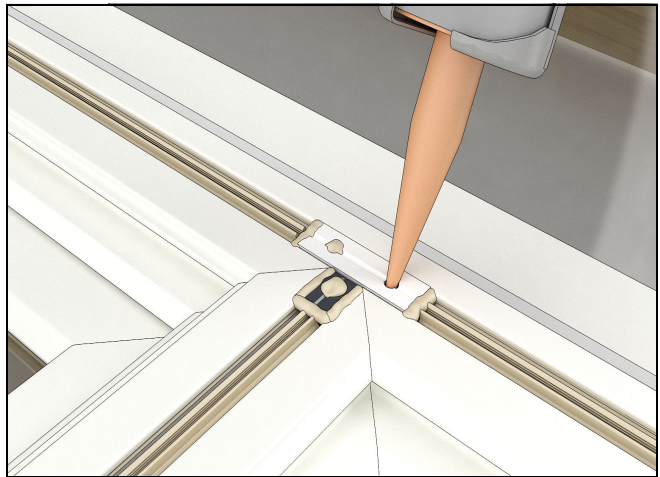

Figure 59

19. Notch exterior mull cover to fit over end plugs by 1" +/- 1/4" from end. Notch the cover to fit over center plugs within 1/4" as seen in Figure 60.



Figure 60

20. Ensure exterior surfaces of frames are clean and dry for optimum tape adhesion.

21. Dog ear both pieces of backing on the tape on the exterior cover on one end. Seat exterior mull cover into the mull weather strip. Ensure the exterior cover barb is completely seated into the kerf of the weather strip.

22. Completely remove backing from tape on exterior mull cover. Apply even pressure along the entire length of exterior cover ensuring tape is fully adhered and barb is fully seated. See Figure 61.

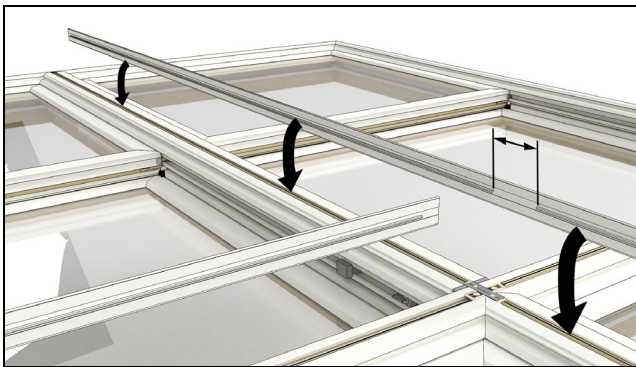

Figure 61

23. Apply nailing fin connector at the sill (and jambs as needed) centered over the gap between separate nailing fins as needed by removing the paper backing from the connector and pressing into place. Then seal around the edges with sealant as shown. See Figure 62.

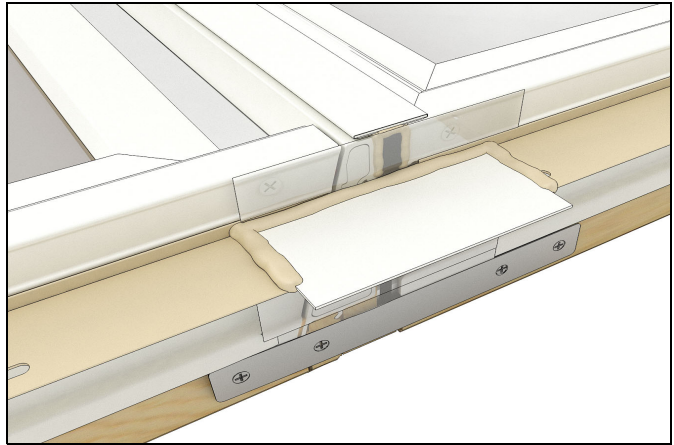

Figure 62

24. If applicable, jamb extensions can now be installed. Follow installation instructions for installing unit into rough or masonry opening.

NOTE: NOTE: Interior mull trim should be applied only after unit is completely installed and interior trim is applied.