

MARVIN ELEVATE™ COLLECTION
OUTSWING FRENCH DOOR

MO (mm)	2-6 13/16 (783)				2-8 13/16 (834)				3-0 13/16 (935)				
RO (mm)	2-7 5/16 (796)				2-9 5/16 (846)				3-1 5/16 (948)				
FS (mm)	2-6 5/16 (770)				2-8 5/16 (821)				3-0 5/16 (923)				
DLO (mm)	21 11/32 (542)				23 11/32 (593)				27 11/32 (695)				
6-7 3/4 (2026) 6-8 (2032) 6-7 1/2 (2019) 67 3/32 (1704)													
6-10 1/4 (2089) 6-10 1/2 (2096) 6-10 (2083) 69 19/32 (1768)													
7-2 1/4 (2191) 7-2 1/2 (2197) 7-2 (2184) 73 19/32 (1869)													
7-11 3/4 (2432) 8-0 (2438) 7-11 1/2 (2426) 83 3/32 (2111)													

Outswing Door Operation

X signifies an operating door panel, O means stationary. Listing the panels in a door starts from the left to the right, looking from the exterior.

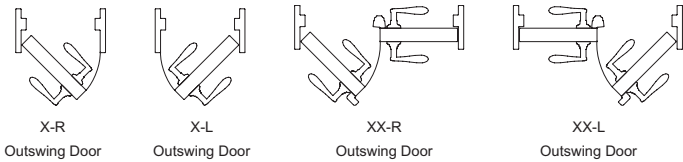

Direct Glaze Over Outswing French Door

MO (mm)	3-0 13/16 (935)	5-11 1/2 (1816)	8-11 13/16 (2738)
RO (mm)	3-1 5/16 (948)	6-0 (1829)	9-0 5/16 (2751)
FS (mm)	3-0 5/16 (923)	5-11 (1803)	8-11 5/16 (2726)
DLO (mm)	31 15/16 (811)	66 5/8 (1692)	102 15/16 (2615)
1-4 (406) 1-4 1/4 (413) 1-3 3/4 (400) 11 3/8 (289)			
	ELDG3616	ELDG7216	ELDG10816

Details and Elevations not to scale.

O = Stationary X = Operator
 L = Left Hand Panel R = Right Hand Panel

Optional Outswing French Door GBGs, SDLs and SDLs with Spacer Bar are available in a standard Rectangular cut, as shown. Other available lite cuts on page 3.

Direct Glaze units have a 2" jamb extension for 6 9/16" jambs or a 2 1/4" jamb extension for 6 13/16" jambs. When ordering 6 9/16" or 6 13/16" jambs, add 1/4" to width and 1/8" to height of Frame Size (FS), Rough Opening (RO), or Masonry Opening (MO).

For further details and drawings visit the "Tools and Documents" section at Marvin.com.

OUTSWING FRENCH DOOR

Multiple Assemblies – 2 Panel

MO (mm)	4-11 1/2 (1511)	5-3 1/2 (1613)	5-11 1/2 (1816)
RO (mm)	5-0 (1524)	5-4 (1626)	6-0 (1829)
FS (mm)	4-11 (1499)	5-3 (1600)	5-11 (1803)
DLO (mm)	21 11/32 (542)	23 11/32 (593)	27 11/32 (695)

MO (mm)	5-1 1/8 (1553)	6-1 1/8 (1857)
RO (mm)	5-1 5/8 (1565)	6-1 5/8 (1870)
FS (mm)	5-0 5/8 (1540)	6-0 5/8 (1845)

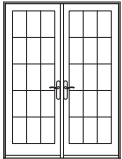
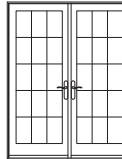
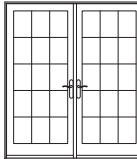
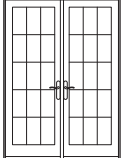
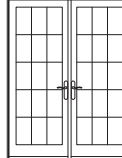
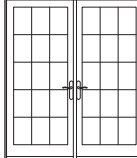
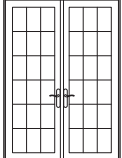
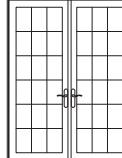
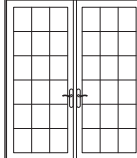
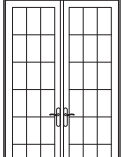
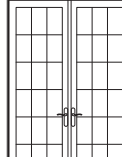
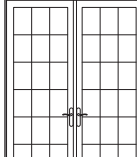
<p>6-7 3/4 (2026) 6-8 (2032) 6-7 1/2 (2019) 67 3/32 (1704)</p>	 ELOFD5065 XXL	 ELOFD5465 XXL	 ELOFD6065 XXL
<p>6-10 1/4 (2089) 6-10 1/2 (2096) 6-10 (2083) 69 19/32 (1768)</p>	 ELOFD5068 XXL	 ELOFD5468 XXL	 ELOFD6068 XXL
<p>7-2 1/4 (2191) 7-2 1/2 (2197) 7-2 (2184) 73 19/32 (1869)</p>	 ELOFD5070 XXL	 ELOFD5470 XXL	 ELOFD6070 XXL
<p>7-11 3/4 (2432) 8-0 (2438) 7-11 1/2 (2426) 83 3/32 (2111)</p>	 ELOFD5080 XXL	 ELOFD5480 XXL	 ELOFD6080 XXL

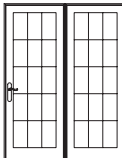
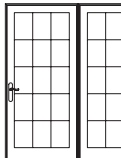
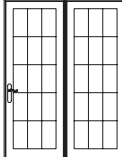
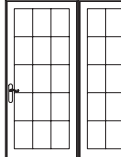
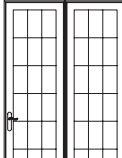
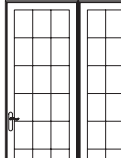
<p>6-7 3/4 (2026) 6-8 (2032) 6-7 1/2 (2019)</p>	 ELOFD2665 / ELOFD2665*	 ELOFD3065 / ELOFD3065*
<p>6-10 1/4 (2089) 6-10 1/2 (2096) 6-10 (2083)</p>	 ELOFD2668 / ELOFD2668*	 ELOFD3068 / ELOFD3068*
<p>7-11 3/4 (2432) 8-0 (2438) 7-11 1/2 (2426)</p>	 ELOFD2680 / ELOFD2680*	 ELOFD3080 / ELOFD3080*

* 2 panel mullied assembly

Construction Details

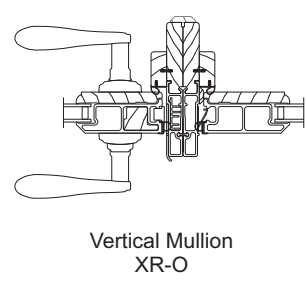
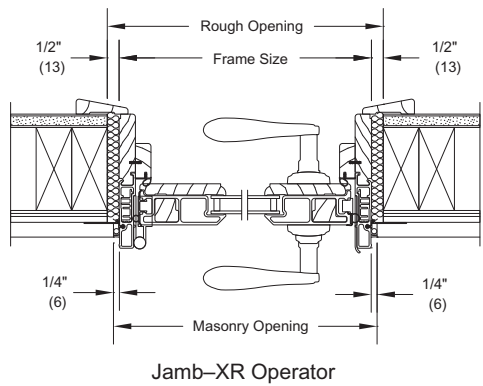
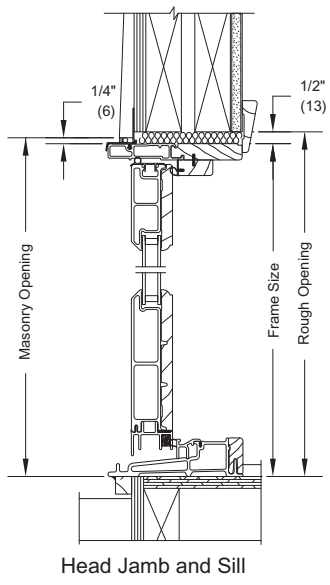

OUTSWING FRENCH DOOR

Multiple Assemblies – 3 Panel

MO (mm)	7-7 7/16 (2323)	7-7 7/16 (2323)	7-7 7/16 (2323)	7-5 13/16 (2281)
RO (mm)	7-7 15/16 (2335)	7-7 15/16 (2335)	7-7 15/16 (2335)	7-6 5/16 (2294)
Frame Size (mm)	7-6 15/16 (2310)	7-6 15/16 (2310)	7-6 15/16 (2310)	7-5 5/16 (2269)



MO (mm)	9-1 7/16 (2780)	9-1 7/16 (2780)	9-1 7/16 (2780)	8-11 13/16 (2738)
RO (mm)	9-1 15/16 (2792)	9-1 15/16 (2792)	9-1 15/16 (2792)	9-0 5/16 (2751)
FS (mm)	9-0 15/16 (2767)	9-0 15/16 (2767)	9-0 15/16 (2767)	8-11 5/16 (2726)



Direct Glaze Over Outswing French Door

MO (mm)	3-0 13/16 (935)	3-0 13/16 (935)	5-11 1/2 (1816)
RO (mm)	3-1 5/16 (948)	3-1 5/16 (948)	6-0 (1829)
FS (mm)	3-0 5/16 (923)	3-0 5/16 (923)	5-11 (1803)

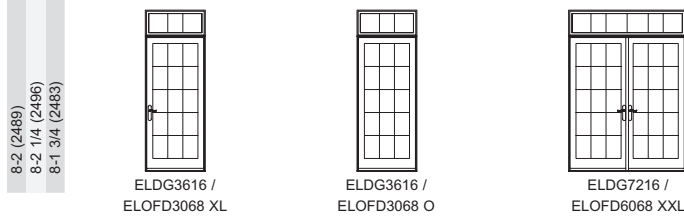

Round Top Over Outswing French Door

MO (mm)	5-11 1/2 (1816)
RO (mm)	6-0 (1829)
FS (mm)	5-11 (1803)

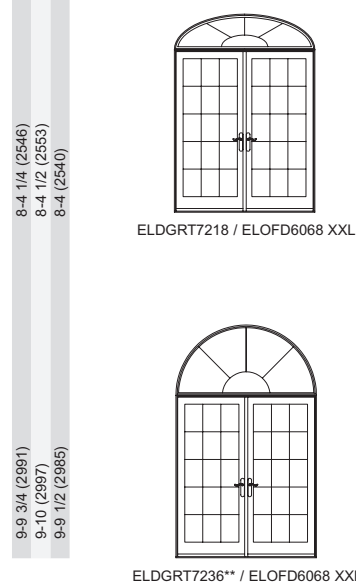

Details and Elevations not to scale.

O = Stationary X = Operator
L = Left Hand Panel R = Right Hand Panel

* 2 and 3 panel XX configurations also available in XX R.

** This product is only available field mullled.

Direct Glaze units have a 2" jamb extension for 6 9/16" jambs or a 2 1/4" jamb extension for 6 13/16" jambs. When ordering 6 9/16" or 6 13/16" jambs, add 1/4" to width and 1/8" to height of Frame Size (FS), Rough Opening (RO), or Masonry Opening (MO).

Optional Direct Glaze GBGs, SDLs and SDLs with Spacer Bar are available in a standard Rectangular cut, as shown. Alternate lite cuts available to align with doors using select lite cut options shown on page 3.

Optional Round Top SDL with Spacer Bar are available in a standard cut, as shown. Round Top GBG cuts are shown on page 35. (Round Top divided lites only available in standard lite cut)

For further details and drawings visit the "Tools and Documents" section at Marvin.com.

MULTIPLE ASSEMBLIES

MAXIMUM ROUGH OPENING not to exceed 109 15/16" x 96" maximum up to 3 units wide by 1 unit high.

MAXIMUM ROUGH OPENING not to exceed 73 5/8" x 100 1/2" maximum up to 2 units wide by 2 unit high.

Field mull kits available not to exceed 110" x 112". True Half Rounds are available field mullled only. Structural mullion reinforcement is required for some assemblies.

Please consult your local Marvin representative for more information.