

DOUBLE HUNG TRANSOM ROUND TOP G2

RT6 TRANSOM EYEBROW ABOVE SPRINGLINE

| RO (mm) | 1-10 1/4 (565) | 2-2 1/4 (667) | 2-6 1/4 (768) | 2-8 1/4 (819) | 2-10 1/4 (870) |
|---------------|------------------|------------------|-----------------|-----------------|-----------------|
| RO Rad. (mm) | 2-0 1/2 (622) | | 2-0 1/2 (622) | | 2-6 1/2 (775) |
| RO (mm) | 1-10 43/64 (576) | 1-11 25/32 (604) | 2-1 5/32 (639) | 2-0 37/64 (624) | 2-1 7/32 (640) |
| RO Spln. (mm) | 1-8 (508) | 1-7 31/32 (507) | 1-7 15/16 (506) | 1-7 31/32 (507) | 1-7 61/64 (507) |
| UDHTRRTG2 | 1612 | 2012 | 2412 | 2612 | 2812 |
| RO (mm) | 2-6 43/64 (779) | 2-7 25/32 (807) | 2-9 5/32 (842) | 2-8 37/64 (827) | 2-9 7/32 (844) |
| RO Spln. (mm) | 2-4 (711) | 2-3 31/32 (710) | 2-3 15/16 (709) | 2-3 31/32 (710) | 2-3 61/64 (710) |
| UDHTRRTG2 | 1620 | 2020 | 2420 | 2620 | 2820 |
| RO (mm) | 2-6 43/64 (779) | 2-7 25/32 (807) | 2-9 5/32 (842) | 2-8 37/64 (827) | 2-9 7/32 (844) |
| RO Spln. (mm) | 2-4 (711) | 2-3 31/32 (710) | 2-3 15/16 (709) | 2-3 31/32 (710) | 2-3 61/64 (710) |
| UDHTRRTG2 | 1620 | 2020 | 2420 | 2620 | 2820 |

| RO (mm) | 3-0 1/4 (921) | 3-2 1/4 (972) | 3-6 1/4 (1073) | 3-10 1/4 (1175) | 5-0 1/4 (1530) |
|---------------|-----------------|-----------------|-----------------|------------------|-----------------|
| RO Rad. (mm) | 2-6 1/2 (775) | | 3-4 1/2 (1029) | | 4-6 1/2 (1384) |
| RO (mm) | 2-1 29/32 (658) | 2-0 25/32 (630) | 2-1 59/64 (658) | 2-3 13/64 (691) | 2-5 3/64 (738) |
| RO Spln. (mm) | 1-7 15/16 (507) | 1-7 63/64 (508) | 1-7 31/32 (507) | 1-7 61/64 (507) | 1-7 61/64 (507) |
| UDHTRRTG2 | 3012 | 3212 | 3612 | 4012 | 5412 |
| RO (mm) | 2-9 29/32 (861) | 2-8 25/32 (833) | 2-9 59/64 (861) | 2-11 13/64 (894) | 3-1 3/64 (941) |
| RO Spln. (mm) | 2-3 15/16 (710) | 2-3 63/64 (711) | 2-3 31/32 (710) | 2-3 61/64 (710) | 2-3 61/64 (710) |
| UDHTRRTG2 | 3020 | 3220 | 3620 | 4020 | 5420 |

CONSTRUCTION DETAILS

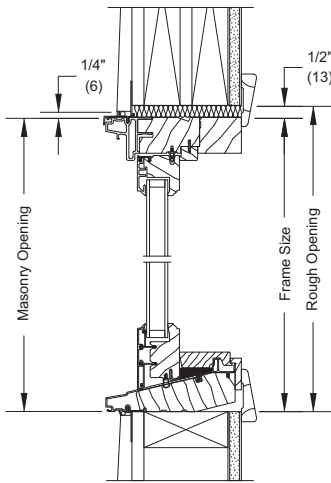

HEAD JAMB AND SILL - TRANSOM

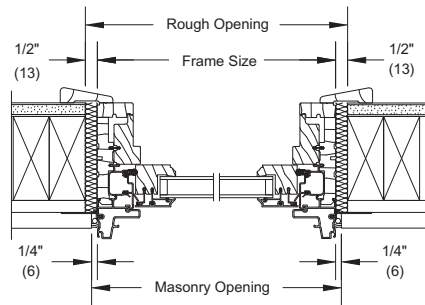













JAMB - TRANSOM

Ultimate Double Hung Transom Round Top G2: UDHTRRTG2

DOUBLE HUNG TRANSOM ROUND TOP G2

RT2 MINIMUM SPRINGLINE

| | | | | | | | | | | |
|--|---|--|---|--|---|--|---|--|---|--|
| RO (mm) | 2-2 1/4 (667) | | 2-6 1/4 (768) | | 2-8 1/4 (819) | | 2-10 1/4 (870) | | 3-0 1/4 (921) | |
| RO Rad. (mm) | 1-1 1/8 (333) | | 1-3 1/8 (384) | | 1-4 1/8 (410) | | 1-5 1/8 (435) | | 1-6 1/8 (460) | |
| RO (mm) RO Spln. (mm) | 1-4 27/32 (428) 0-3 23/32 (94) | | 1-6 27/32 (479) 0-3 23/32 (94) | | 1-7 27/32 (504) 0-3 23/32 (94) | | 1-8 27/32 (529) 0-3 23/32 (94) | | 1-9 27/32 (555) 0-3 23/32 (94) | |
| |  | |  | |  | |  | |  | |
| | UDHTRRTG2 2015 | | UDHTRRTG2 2417 | | UDHTRRTG2 2618 | | UDHTRRTG2 2819 | | UDHTRRTG2 3020 | |
| RO (mm) | 3-2 1/4 (972) | | 3-6 1/4 (1073) | | 3-10 1/4 (1175) | | 5-0 1/4 (1530) | | | |
| RO Rad. (mm) | 1-7 1/8 (486) | | 1-9 1/8 (537) | | 1-11 1/8 (587) | | 2-6 1/8 (765) | | | |
| RO (mm) RO Spln. (mm) | 1-10 27/32 (680) 0-3 23/32 (94) | | 2-0 27/32 (631) 0-3 23/32 (94) | | 2-2 27/32 (682) 0-3 23/32 (94) | | 2-9 27/32 (860) 0-3 23/32 (94) | | | |
| |  | |  | |  | |  | | | |
| | UDHTRRTG2 3221 | | UDHTRRTG2 3623 | | UDHTRRTG2 4025 | | UDHTRRTG2 5432 | | | |
| RO (mm) | 4-11 1/2 (1511) | | 5-7 1/2 (1715) | | 6-3 1/2 (1918) | | | | | |
| RO Rad. (mm) | 2-5 3/4 (756) | | 2-9 3/4 (857) | | 3-1 3/4 (959) | | | | | |
| RO (mm) RO Spln. (mm) | 2-9 15/32 (850) 0-3 23/32 (94) | | 3-1 15/32 (952) 0-3 23/32 (94) | | 3-5 15/32 (1053) 0-3 23/32 (94) | | | | | |
| |  | |  | |  | | | | | |
| | UDHTRRTG2 5834 | | UDHTRRTG2 6638 | | UDHTRRTG2 7442 | | | | | |